

MATRIX

STRENGTH

2024 BROCHURE



Manual Workout

8

3

10

0:19

MATRIX

CONTENTS

4 MATRIX FITNESS

*BELIEVE IN BETTER
WITH YOU EVERY STEP OF THE WAY*

12 CONNECTED SOLUTIONS

*GET CONNECTED TO A WORLD OF
DIGITAL SOLUTIONS*

18 ULTRA SERIES

*THE ULTIMATE STRENGTH
TRAINING EXPERIENCE*

36 VERSA SERIES

*THE POWER OF CHOICE IN
STRENGTH TRAINING*

58 AURA SERIES

*THE STANDARD IN PERFORMANCE
AND DESIGN*

82 GO SERIES

DISCOVER THE STRENGTH OF SIMPLICITY

92 MAGNUM SERIES

*A LEGACY OF PERFORMANCE AND
PROVEN DURABILITY*

130 VARSITY SERIES

*DESIGNED FOR SUPERIOR VALUE
AND TRAINING VARIETY*

138 G1 SERIES

*DIVERSITY AND DURABILITY
TO GET THE JOB DONE*

BELIEVE IN BETTER

At Matrix, it's our mission to make your fitness facility everything you ever dreamed it could be.

Count on us for meaningful innovations that make our equipment a joy to own, service and use. Expect a technology ecosystem that enhances the way you manage your facility, retain and engage members and promote your brand. And as always, trust us to put your brand and your business first, supporting you with facility planning, dedicated sales and support, unmatched customer service and extensive education and training.

For those who believe in better, there's Matrix.

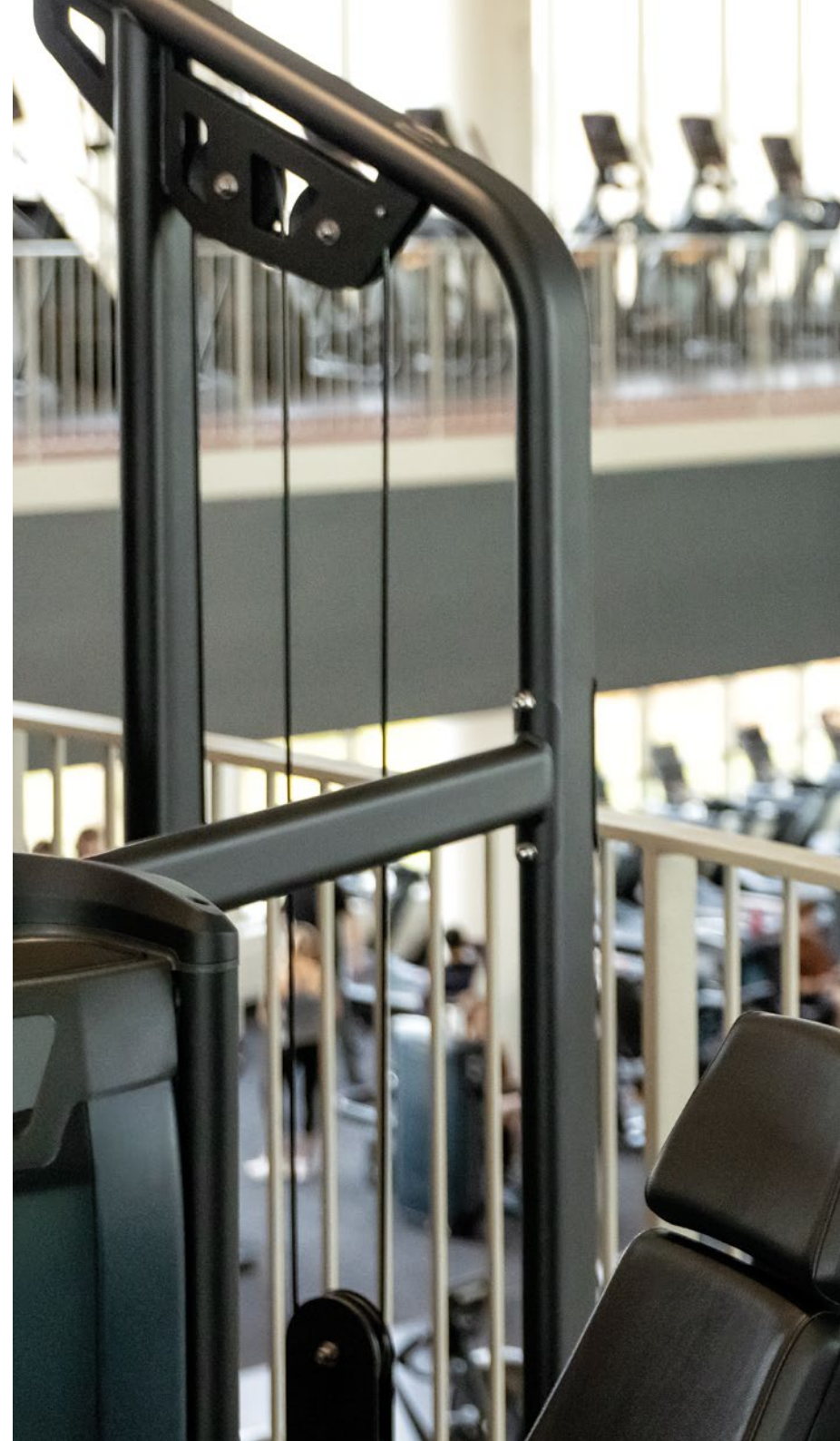







WITH YOU EVERY STEP OF THE WAY

When you choose Matrix, you're getting a partner who will be there, for your grand opening and every day after.

DESIGNING YOUR VISION

Our team will work with you to bring your vision of fitness to life by helping you select equipment and technology ideal for your goals, your space and the people you serve. We'll even work with you to develop financial solutions that expand your options and maximize your investments.

CREATING YOUR VISION

Count on our commitment to a seamless delivery and installation process, tailored to your schedule. Additionally, your team can look forward to a comprehensive demonstration, empowering them to master the utilization of your new equipment and unleash its full potential.

SUPPORTING YOUR VISION

As your dedicated partner, you can rely on our swift service response times, readily available service parts and our unwavering commitment to resolving issues correctly the first time. To enhance the value of your investment, your team will also receive access to Matrix Learning Center, a comprehensive digital resource featuring product training, maintenance tips, on-demand educational videos and more. And count on our marketing support kits to seamlessly engage with your audience, spotlight your brand, and showcase your offerings.

STRENGTH OVERVIEW

ULTRA SERIES /

Powerful yet comfortable. Advanced functionality with intuitive operation. The industry's most durable components wrapped in breathtaking industrial design. The Ultra Series goes beyond your expectations of strength training equipment to earn and retain members like nothing else.

VERSA SERIES /

Bring your vision of fitness to life — our most versatile series gives you the options to build a strength training area that fits your space and the needs of your members in a beautifully precise way. The Versa Series incorporates advanced biomechanics for a natural, smooth, efficient workout experience.

AURA SERIES /

Superior styling made the Aura Series an instant classic. Signature features made it one of the most-imitated product lines in the industry. Choose the Aura Series, and you'll discover that beginners and fitness enthusiasts alike will be drawn to something that the competition can't imitate — an unmistakable aura of greatness.

GO SERIES /

Now you can engage users new to strength training and circuit programs with our easy-to-use, space-efficient Go Series. Minimal adjustments, low starting weights and smaller progressions create a welcoming experience where anyone can sit and go, while compact footprints, back-to-back designs, and low stack heights fit your space and budget.

MAGNUM SERIES /

Born from a long tradition of premium performance, there's no better choice for professional athletes than the unrivaled performance and durability of the Magnum Series. Advanced options like Breaker Benches and MEGA Racks help athletes reach their potential, and the impeccable designs stand up to the most demanding environments.

VARSITY SERIES /

For a blend of performance and value perfect for heavy-use facilities, look no further than the Varsity Series. It offers the dynamic performance and superior ergonomics that the fitness world has come to expect from Matrix, plus the uncompromising durability you need to accommodate a steady stream of users.

G1 SERIES /

The G1 Series provides an ideal blend of value and variety for cost-conscious facilities. It offers a range of durable options with a classic look. From space-saving multi-station units to ever-popular benches, this series will meet your members' needs for years to come.



MATRIX CONNECTED SOLUTIONS /

GET CONNECTED TO A WORLD OF DIGITAL SOLUTIONS

You want to deliver an unmatched fitness experience, and Matrix Connected Solutions gives you the flexible tools you need to do it your way, regardless of the size of your facility or budget.

With the power of our robust, open platform at your fingertips, service and maintenance become hassle-free. Your trainers can connect and engage with members in new ways for better results and more referrals. Everyone who comes through your doors can instantly connect to their favorite music, entertainment and social networks. It's easier than ever to expand your marketing efforts and make your brand the center of each member's fit lifestyle. And that's just a taste of what Matrix Connected Solutions can do. Discover how our complete selection of hardware and software solutions can help bring your vision of fitness to life in bigger, bolder, brighter ways than ever before.



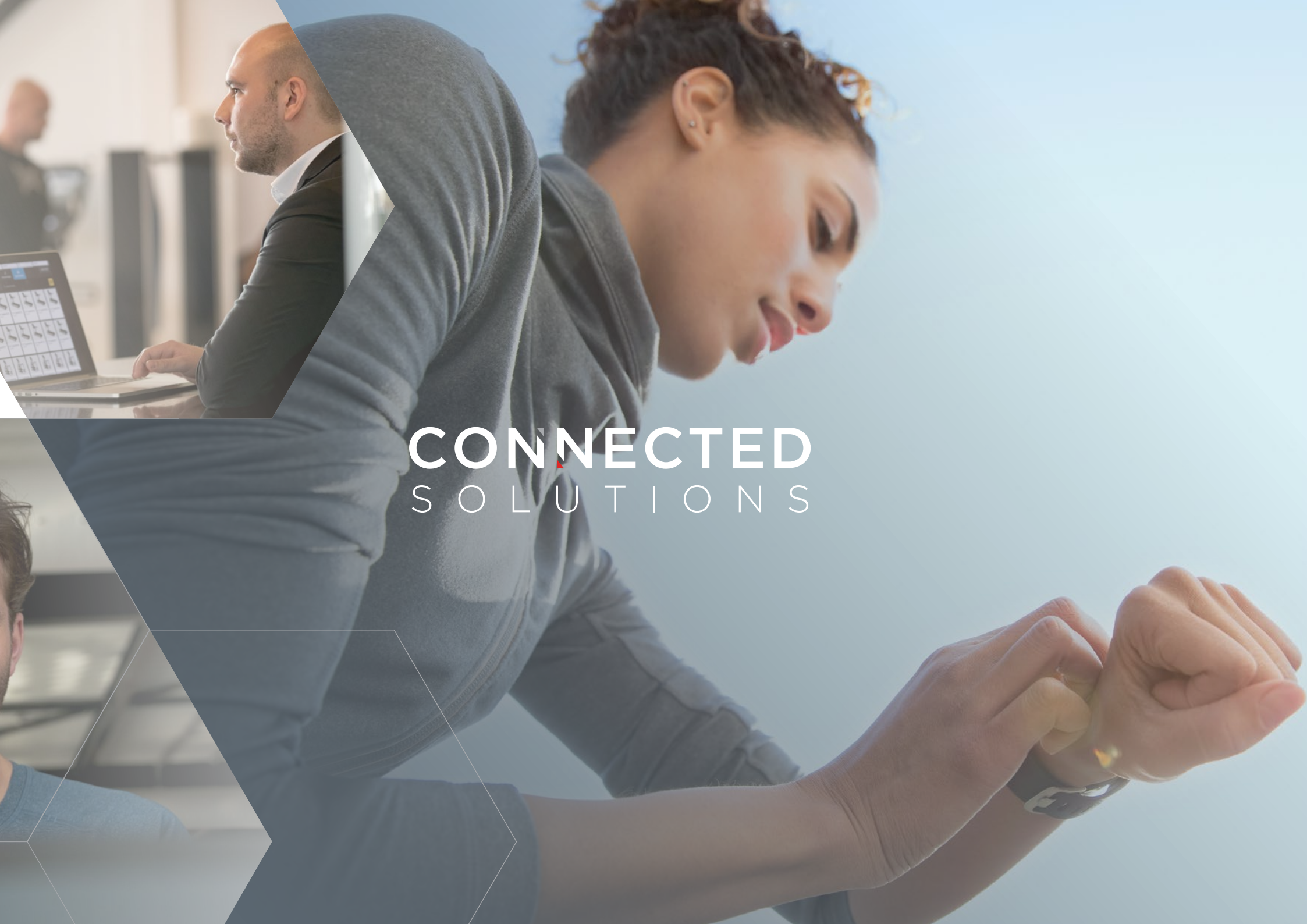

CONNECTED
SOLUTIONS

MATRIX CONNECTED SOLUTIONS /
YOUR GOALS

You have a vision of fitness that's all your own.

The flexibility of our complete digital ecosystem lets you choose how you enhance your business, streamline your administrative tasks, impress the people you serve and much more.

INCREASE RETENTION

Bringing members back again is essential to the success of your business. With our smart digital options, they won't just come back — they'll bring friends.

BUILD ENGAGEMENT

Keep your members enthused, excited and eager for more with powerful tools that keep the exercise experience fresh.

BOOST REVENUE

Find out how to tap forward-thinking revenue streams that can redefine your bottom line in powerful new ways.

MAXIMIZE ROI

Count on us for smart tools that streamline the way you run your business while maximizing your investment and the value of every membership.

ENHANCE DIFFERENTIATION

Your facility is one of a kind, and our game-changing Connected Solutions can help you build your brand and stand out in impactful ways.

ENERGIZE ACQUISITION

You're always striving to bring in new members, and we can help extend your brand, reach untapped demographics and impress everyone who stops by.



A man with a focused expression is looking at a large, dark smart console mounted on a piece of gym equipment. The console displays a large white number '1' in the center, with a yellow arc above it. To the right of the number, there are several horizontal bars and a green play button icon. The background is dark and slightly out of focus, showing other gym equipment.

MATRIX CONNECTED SOLUTIONS /

SMARTER IS STRONGER

When you choose Ultra Series with Intelligent Training Console, you'll get a digitally connected, guided experience. The intuitive touchscreen makes it easy for members of all levels to define physical transformation targets, identify their benchmark weight and receive step-by-step instructions. Then members can take on personalized progression programs that will help them reach their goals in smart new ways.

With convenience features like, touch-free RFID login and stored seat settings, they'll be able to easily start a workout, transition between equipment and review previous workouts to chart their development—maximizing their time and results. Our WiFi-enabled console also works seamlessly with our digital portfolio of Connected Solutions, including Engage 360, Community 360 and Asset Management.

ENGAGE 360 /
**CONNECTED TRAINING. REAL RELATIONSHIPS.
AMAZING RESULTS.**

Now you can reach more members wherever they are and forge lasting connections with our Engage 360 platform. Engage 360 lets your staff access and create training libraries, assign workouts to individuals or groups, cheer on members, track progress, manage calendars, monitor member engagement and more.

COMMUNITY 360 /
STRONGER. FITTER. BETTER. TOGETHER.

Bring members together in a whole new way and keep them coming back for more with our Community 360 app. Community 360 makes it easy to create a virtual fitness community that's always active with fresh ways for members to stay fit, share their triumphs and cheer each other on, all while consolidating member workout data under your brand.

ASSET MANAGEMENT /
**KEEPING AN EYE ON YOUR EQUIPMENT
SO YOU DON'T HAVE TO**

Our industry-leading Asset Management platform offers a 360-degree view of your strength training equipment on virtually any internet-connected device. Easy-to-read color-coding tells you whether a product is functioning properly, detects errors and alerts you if something is offline. Whether you manage one facility or many, the system can create customized reports to help maximize product life and identify the optimum product mix. It also improves communication with Matrix and your service provider, streamlining maintenance and repair while reducing paperwork and hassle. The customizable interface even provides an array of smart marketing tools to help you get more members into your facility.

RFID /
**STREAMLINE YOUR MEMBERS'
EXERCISE EXPERIENCE**

RFID is a smart way to streamline your members' strength training experience. Simple radio-frequency tags make check-in, program loading and workout tracking completely touch-free and virtually automatic. Members can even use RFID with your existing RFID-compatible vending machines, kiosks and in-facility sales centers for quick impulse buys of your branded merchandise, snacks, beverages and more.



ULTRA SERIES /

THE ULTIMATE STRENGTH TRAINING EXPERIENCE

ULTRA SERIES /

The powerful and comfortable Ultra Series gives you the most advanced functionality with an intuitive design that couldn't be easier to operate. All Ultra Series equipment is designed for smooth converging and diverging movements to encourage a natural path of motion and enhance user comfort. Ultra Series also includes Action Specific Grips to reduce stress on contact points and a uniformly low stack height (122 cm / 48") to improve the aesthetic of your fitness center. Both durable and beautiful, the Ultra Series will exceed your expectations when it comes to earning and retaining members.

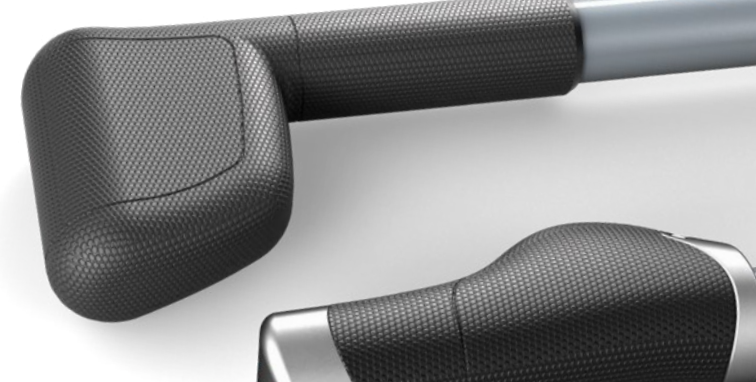

User Amenities All single-station units offer a convenient accessory pad, personal device holder and towel hook.

Incremental Weights Easy to access and reference from the seated position. **Electronic Rep Counter** Tracks reps, activity time, and rest time for enhanced user data tracking and a streamlined workout experience.

Independent Converging/Diverging Motion Encourages a natural path of motion to enhance comfort.

Exercise Placards Easy-to-read reference cards highlight targeted muscle groups and proper machine use. **Action Specific Grips** Ergonomically designed to reduce stress on contact points while enhancing feel, function and form.

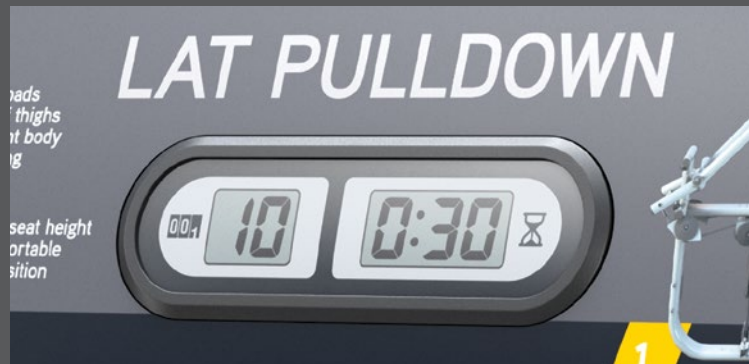

*Ultra Base models exclude Action Specific Grips, electronic rep counters, aluminum tops, incremental weights and aluminum seat links.

ULTRA SERIES WITH INTELLIGENT TRAINING CONSOLE /

ULTRA: THE SMART CHOICE

Our powerful Ultra Series just got better and smarter with the addition of our new Intelligent Training Console. When you choose Ultra Series with Intelligent Training Console, you'll get a digitally connected, guided experience that will give those new to strength training a reason to sign up with your facility and those who already love it a reason to return. Members begin by defining their physical transformation target and receiving step-by-step equipment instruction. The intuitive interface makes it easy to identify their benchmark weight and start a personalized progression program. They'll also be able to review previous workouts to chart their development, helping them maximize their results and reach their individual goals more efficiently than ever.



A GUIDED TRAINING EXPERIENCE

Ideal for those new to strength training or experienced members who are struggling to progress, Intelligent Training Console features Endurance, Build and Strength programs to give members a guided training experience specific to their goals.

ORIGINAL PROGRESSIONS

Original progression-based programming designed in collaboration with the National Strength and Conditioning Association (NSCA) helps members find a benchmark weight and provides 8–12 weeks of workouts to maximize results.

EXPLOSIVE LIFTING

The explosive lifting program focuses on speed and power instead of just strength, helping members accelerate results while keeping the strength training experience fresh.

WORKOUT HISTORY

Workout history snapshot lets members quickly review past sessions and track overall progress.

DEMO VIDEOS

On-console demo videos provide guidance on maintaining proper form for each exercise.

INTUITIVE NAVIGATION

Intuitive touchscreen console navigation makes it easy for members of any ability or experience level to get started.

DUAL USER SIGN-IN

Dual user sign-in streamlines transitions between two alternating users and their specific strength training programs.

RECORDED SETTINGS

Stored seat settings make it easy for users to find the same ergonomically sound fit every time they work out.

TOUCH-FREE LOGIN

Included RFID capability gives users a quick, touch-free way to login, load their personal preferences and start their workout.

FULLY CONNECTED TECHNOLOGY

Internet connectivity via WiFi or ethernet provides access to included Asset Management and optional add-ons, such as Community 360 and Engage 360.

BRAND-BUILDING CUSTOMIZATION

Customizable interface strongly represents your brand to provide a unified look and feel throughout your entire facility.

INTELLIGENT TRAINING CONSOLE SPECIFICATIONS

CONSOLE	
Display Type	40.6 cm / 16" capacitive touchscreen LCD
Display Feedback	Reps, sets, rest time, heart rate, total weight, lift time
Workouts	Manual, endurance, build, custom, strength*, explosive lifts*
User-defined Multi-language Display	English, German, French, Italian, Spanish, Dutch, Portuguese, Chinese-S, Chinese-T, Japanese, Korean, Swedish, Finnish, Russian, Arabic, Turkish, Polish, Welsh, Basque, Vietnamese, Somali, Danish, Malaysian, Catalan, Thai, Greek
Lift to Start	Yes
Ethernet	Yes
WiFi	Yes
Bluetooth	Yes; heart rate
USB Port	Software updates only
RFID Wireless Login	Yes
Dual User Sign-in	Yes
CSAFE Ready	Yes
Community 360 Compatible	Yes
Facility Communication Portal / Calendar	No
Engage 360 Compatible	Yes
EGYM Compatible	Yes
Asset Management Compatible	Yes
Stored User Settings	Yes- Seat settings and Bluetooth HR
Strength Series Compatibility	Ultra Series June 2022 or newer
TECH SPECS	
Power Requirements	100-240V / 50-60Hz AC
Assembled Dimensions	147.3 cm / 58" (As assembled on the Ultra weight stack)
Shipping Dimensions	51 x 42 x 25 cm / 20.1" x 16.5" x 9.8"
Shipping Weight	9.4 kg / 21 lbs.

* Workout program only available on certain modalities



CONVERGING CHEST PRESS

Independent converging movement provides a natural path of motion • Adjustable back pad with gas assist facilitates easy range of motion changes • Integrated foot platform provides additional user stability and comfort during use • Designed for easy entry and exit • Available as Ultra Base G7-S21B and Ultra Base Heavy Stack G7-S21BH

	PRODUCT DIMENSIONS (L X W X H)						PRODUCT WEIGHT		WEIGHT STACK	
	CM		INCHES				KG	LBS	KG	LBS
G7-S13	168.5	141	135	66.3	55.4	53	348	768	108	240



LATERAL RAISE

Oversized arm pads enhance comfort and accommodate a variety of users • Rotating handles provide natural motion • Available as Ultra Base G7-S21B and Ultra Base Heavy Stack G7-S21BH

	PRODUCT DIMENSIONS (L X W X H)						PRODUCT WEIGHT		WEIGHT STACK	
	CM		INCHES				KG	LBS	KG	LBS
G7-S21	105.5	150	135	41.5	59	53	281	620	90	200



PEC FLY / REAR DELT

Rotating grips provide comfort and smooth movement during use • Angled back pad and delt grips enhance user comfort and improve biomechanics • Oversized handles reduce the need to adjust the seat position between rear deltoid and fly exercises • Heavy weight stack accommodates advanced users • Available as Ultra Base G7-S22B and Ultra Base Heavy Stack G7-S22BH

	PRODUCT DIMENSIONS (L X W X H)						PRODUCT WEIGHT		WEIGHT STACK	
	CM		INCHES				KG	LBS	KG	LBS
G7-S22	143.5	193.5	197	56.4	76.1	77.6	329	726	135	300



CONVERGING SHOULDER PRESS

Independent converging movement provides a natural path of motion • Dual-position hand grips allow for greater training variety • Counterbalanced pressing arms provide reduced starting resistance • Reclining seat position allows for better posture and back support • Available as Ultra Base G7-S23B and Ultra Base Heavy Stack G7-S23BH

	PRODUCT DIMENSIONS (L X W X H)						PRODUCT WEIGHT		WEIGHT STACK	
	CM		INCHES				KG	LBS	KG	LBS
G7-S23	168	146.5	174	66.1	57.6	68.4	359	792	90	200



DIVERGING LAT PULLDOWN

Independent diverging movement provides a natural path of motion • Angled seat encourages proper user position • High pads and seat easily adjust to provide stability, comfort and improved ergonomics • Available as Ultra Base G7-S33B and Ultra Base Heavy Stack G7-S33BH

	PRODUCT DIMENSIONS (L X W X H)						PRODUCT WEIGHT		WEIGHT STACK	
	CM		INCHES				KG	LBS	KG	LBS
G7-S33	152	161	195	59.6	63.1	76.7	382	842	108	240



DIVERGING SEATED ROW

Independent diverging movement provides a natural path of motion • Dual-position foot placement provide greater user comfort • Adjustable chest pad with gas shock accommodates a variety of users • Available as Ultra Base G7-S34B and Ultra Base Heavy Stack G7-S34BH

	PRODUCT DIMENSIONS (L X W X H)						PRODUCT WEIGHT		WEIGHT STACK	
	CM		INCHES				KG	LBS	KG	LBS
G7-S34	158	138.5	140.5	62.2	54.5	55.3	343	757	108	240



INDEPENDENT BICEPS CURL

Unique pivoting elbow pads and rotating handles improve function, comfort and feel during use • Designed for easy entry and exit without chest compression from traditional machines • Elbow pad wear covers improve upholstery performance in high contact areas • Available as Ultra Base G7-S40B and Ultra Base Heavy Stack G7-S40BH

	PRODUCT DIMENSIONS (L X W X H)						PRODUCT WEIGHT		WEIGHT STACK	
	CM		INCHES				KG	LBS	KG	LBS
G7-S40	135	168	135	53	66.2	53	266	587	90	200



DEPENDENT ARM CURL

Rotating Action Specific Grips provide greater comfort and minimal point pressure • Arm pad is angled for stability and limits unwanted shoulder movement during exercise • Elbow pad wear cover improves upholstery performance and durability in high contact areas • Color-coded pivot indicates correct elbow placement for optimal feel and performance • Available as Ultra Base G7-S41B and Ultra Base Heavy Stack G7-S41BH

	PRODUCT DIMENSIONS (L X W X H)						PRODUCT WEIGHT		WEIGHT STACK	
	CM		INCHES				KG	LBS	KG	LBS
G7-S41	149	106.5	135	59	42	53	225	496	90	200



TRICEPS PRESS

Oversized rotating handles adapt to a wide variety of users and provide exercise variation • Angled back pad reduces stress, improves stabilization and enhances comfort • Available as Ultra Base G7-S42B and Ultra Base Heavy Stack G7-S42BH

G7-S42	PRODUCT DIMENSIONS (L X W X H)						PRODUCT WEIGHT		WEIGHT STACK	
	CM			INCHES			KG	LBS	KG	LBS
	124	121	135	48.8	47.7	53	305	673	120	265



TRICEPS EXTENSION

Handles pivot to automatically adjust for varying forearm lengths • Padded hand rests provide a comfortable and stable pressing surface while reducing point pressure on the hands • Action Specific Grips provide greater comfort and tailored hand position for the movement • Color-coded pivot indicates correct elbow placement for optimal feel and performance • Foot pegs provide additional stability and support during heavy lifts • Available as Ultra Base G7-S45B and Ultra Base Heavy Stack G7-S45BH

G7-S45	PRODUCT DIMENSIONS (L X W X H)						PRODUCT WEIGHT		WEIGHT STACK	
	CM			INCHES			KG	LBS	KG	LBS
	144.5	106.5	135	57	42	53	243.5	537	81	180



ABDOMINAL CRUNCH

Sculpted back pads allow for full muscular contraction • Dual-supported pivoting design fosters a natural abdominal crunch motion • Self-aligning handles adjust to accommodate a variety of users, and elbow pad covers protect the upholstery at touchpoints • Available as Ultra Base G7-S51B and Ultra Base Heavy Stack G7-S51BH

	PRODUCT DIMENSIONS (L X W X H)						PRODUCT WEIGHT		WEIGHT STACK	
	CM	INCHES		KG	LBS	KG	LBS	KG	LBS	
G7-S51	139	121	147	54.6	47.5	57.9	290	640	108	240



BACK EXTENSION

Multi-position foot placement accommodates a variety of users • Thumb-switch controls allow easy adjustments • Contoured back pad enhances user comfort and provides additional support • Available as Ultra Base G7-S52B and Ultra Base Heavy Stack G7-S52BH

	PRODUCT DIMENSIONS (L X W X H)						PRODUCT WEIGHT		WEIGHT STACK	
	CM	INCHES		KG	LBS	KG	LBS	KG	LBS	
G7-S52	145	120	135	57.2	47.3	53	319	704	108	240



ROTARY TORSO

Kneeling position minimizes low-back stress while stretching hip flexors • Contoured knee pads with wear covers enhance comfort, stability and durability • Oversized handlebars accommodate a variety of users without adjustment • Knee pad wear cover improves upholstery performance in high contact areas • Range of motion feature with 8 different start positions adds greater versatility • Available as Ultra Base G7-S55B and Ultra Base Heavy Stack G7-S55BH

	PRODUCT DIMENSIONS (L X W X H)						PRODUCT WEIGHT		WEIGHT STACK	
	CM	INCHES		KG	LBS	KG	LBS	KG	LBS	
G7-S55	117	123	141	45.8	48.2	55.2	232	512	90	200



LEG PRESS

Angled and adjustable seat carriage enhances comfort • Ergonomic adjustment handle and gas shock enable simple changes in start position • Oversized foot platform increases movement variety including calf exercises • Integrated assistance handle enables easy exit and entry • Guide rod and bearing-designed carriage improves long-term durability and smooth performance • Available as Ultra Base G7-S70B and Ultra Base Heavy Stack G7-S70BH

	PRODUCT DIMENSIONS (L X W X H)						PRODUCT WEIGHT		WEIGHT STACK	
	CM			INCHES			KG	LBS	KG	LBS
G7-S70	206	113	152	80.9	44.3	59.9	436	962	180	400



LEG EXTENSION

Self-adjusting tibia pad for greater ease of use • Soft contoured knee pad provides optimal comfort behind user's knee during use • Thumb-switch controls and ergonomic adjustment handle allow easy user setup • Angled seat and back pads encourage full quadriceps contraction • Pivot location clearly marked to encourage correct knee alignment • Available as Ultra Base G7-S71B and Ultra Base Heavy Stack G7-S71BH

	PRODUCT DIMENSIONS (L X W X H)						PRODUCT WEIGHT		WEIGHT STACK	
	CM			INCHES			KG	LBS	KG	LBS
G7-S71	152.4	125.9	135	60	49.6	53	304	671	108	240



SEATED LEG CURL

Back pad, tibia pad and range-of-motion adjustments are easily accessible from a seated position • Angled seat and unique pivot location encourage full hamstring contraction • Gas-assisted adjustable thigh pad and thumb switch control allow easy user setup • Soft contoured thigh pad provides optimal comfort during use • Available as Ultra Base G7-S72B and Ultra Base Heavy Stack G7-S72BH

	PRODUCT DIMENSIONS (L X W X H)						PRODUCT WEIGHT		WEIGHT STACK	
	CM		INCHES				KG	LBS	KG	LBS
G7-S72	148.5	117	135	58.4	46	53	320	706	90	200



PRONE LEG CURL

Contoured elbow pads enhance stabilization and comfort • Divergent pad angle eliminates lower-back stress • Integrated sweat guard protects frame from damage • Thumb-switch controls allow easy adjustments • Available as Ultra Base G7-S73B and Ultra Base Heavy Stack G7-S73BH

	PRODUCT DIMENSIONS (L X W X H)						PRODUCT WEIGHT		WEIGHT STACK	
	CM		INCHES				KG	LBS	KG	LBS
G7-S73	173	112	135	68	44	53	280	618	90	200



HIP ADDUCTOR

Ergonomic adjustment handle enables simple changes in start position • Foot pegs and contoured knee pads provide user stabilization and support • Adjustable reclining position offers customized lumbar comfort • Integrated foot platform allows easy exit and entry • Available as Ultra Base G7-S74B and Ultra Base Heavy Stack G7-S74BH

	PRODUCT DIMENSIONS (L X W X H)							PRODUCT WEIGHT		WEIGHT STACK	
	CM			INCHES				KG	LBS	KG	LBS
G7-S74	182	173	135	71.6	67.8	53	272	600	90	200	



HIP ABDUCTOR

Ergonomic adjustment handle enables simple changes in start position • Foot pegs and contoured knee pads provide user stabilization and support • Adjustable reclining position offers customized lumbar comfort • Integrated foot platform allows easy exit and entry • Available as Ultra Base G7-S75B and Ultra Base Heavy Stack G7-S75BH

	PRODUCT DIMENSIONS (L X W X H)							PRODUCT WEIGHT		WEIGHT STACK	
	CM			INCHES				KG	LBS	KG	LBS
G7-S75	182	173	135	71.6	68	53	277	611	90	200	



CALF EXTENSION

Angled seat position provides greater lumbar support • Ergonomic adjustment handle enables simple changes in start position • Range-of-motion adjustment accommodates a variety of users and start positions • Guide rod and bearing-designed carriage improves long-term durability and smooth performance • Available as Ultra Base G7-S77B and Ultra Base Heavy Stack G7-S77BH

	PRODUCT DIMENSIONS (L X W X H)							PRODUCT WEIGHT		WEIGHT STACK	
	CM		INCHES					KG	LBS	KG	LBS
G7-S77	169	120	150	66.5	47.2	59	291	642	180	400	



GLUTE

Upright user position increases comfort and machine approachability • Rotating foot pad provides stable and smooth contact throughout the full range of motion • Oversized foot platform bolsters stability • Adjustable chest pad accommodates a variety of users • Available as Ultra Base G7-S78B and Ultra Base Heavy Stack G7-S78BH

	PRODUCT DIMENSIONS (L X W X H)						PRODUCT WEIGHT		WEIGHT STACK	
	CM		INCHES				KG	LBS	KG	LBS
G7-S78	200.5	90	156	79	35.3	61.5	239	527	63	140

ULTRA STANDARD FRAME AND UPHOLSTERY COLORS

Iced Silver frames

Obsidian Black – Upholstery



Graphite Gray – Upholstery



Clay Red – Upholstery



Alloy Gray / Graphite Gray – Upholstery



Slate Blue – Upholstery



Alloy Gray / Hazelnut – Upholstery



Matte Black frames

Obsidian Black – Upholstery



Graphite Gray – Upholstery



Clay Red – Upholstery



Alloy Gray / Graphite Gray – Upholstery



Slate Blue – Upholstery



Alloy Gray / Hazelnut – Upholstery



NOTE: All specifications are subject to change without notice. Actual products may differ from those pictured in this catalog. Actual product colors may vary from what is shown here.



VERSA SERIES /

THE POWER OF CHOICE IN STRENGTH TRAINING



VERSA SERIES /

The Versa Series offers a wide range of options — like standard or heavy weight stacks and optional foot support kits — so you can assemble a collection just right for your space, members and budget. Count on the Versa Series for a mix of advanced biomechanics and smart options that will bring your vision of fitness to life.



Exercise Placards Easy-to-read reference cards highlight targeted muscle groups and proper machine use. **Converging/Diverging Motion** Encourages a natural path of motion to enhance comfort. **Incremental Weights** Easy to access and reference from the seated position. **Action Specific Grips** Ergonomically designed to reduce stress on contact points while enhancing feel and form (Versa+ package). **Electronic Rep Counter** Tracks reps, activity time and rest time for a streamlined workout experience (Versa+ package). **Gas-assisted Seat Adjustment** Offers smooth, instant adjustment, with a 4-bar linkage for increased stability (Versa+ package).

VERSA OPTIONS

VERSA+

(shown throughout brochure)

Comes with:

- Action Specific Grips
- Gas-assisted Seat Adjustment
- Electronic Rep Counter/Timer
- Decorative Top Wing
- Ergonomic Adjustment Handles
- Heavy Weight Stack
- Incremental Weight

WEIGHT STACK

- Choose between Standard and Heavy Weight Stack

OPTIONAL FOOT SUPPORT KIT

Available on:

- Converging Chest Press
- Converging Shoulder Press
- Biceps Curl
- Back Extension





CONVERGING CHEST PRESS

Independent converging movement provides a natural path of motion • Designed for easy entry and exit • Adjustable start position facilitates increased range of motion

	PRODUCT DIMENSIONS (L X W X H)					PRODUCT WEIGHT		WEIGHT STACK		
	CM	INCHES				KG	LBS	KG	LBS	
VS-S13	139.3	134.7	160.8	54.9	53	63.3	230	508	72	160
VS-S13P	139.3	134.7	167.1	54.9	53	65.8	265	584	104	230
VS-S13H	139.3	134.7	160.8	54.9	53	63.3	262	578	104	230



CONVERGING SHOULDER PRESS

Independent converging movement provides a natural path of motion • Dual-position hand grips allow for greater training variety • Counterbalanced pressing arms provide reduced starting resistance

	PRODUCT DIMENSIONS (L X W X H)					PRODUCT WEIGHT		WEIGHT STACK		
	CM	INCHES				KG	LBS	KG	LBS	
VS-S23	171	143.7	203.6	67.3	56.6	80.1	245	538	72	160
VS-S23P	171	143.7	203.6	67.3	56.6	80.1	279	614	104	230
VS-S23H	171	143.7	203.6	67.3	56.6	80.1	276	608	104	230



DIVERGING LAT PULLDOWN

Independent diverging movement provides a natural path of motion • Angled seat encourages proper user position • Thigh pad easily adjusts for stability and comfort

	PRODUCT DIMENSIONS (L X W X H)						PRODUCT WEIGHT		WEIGHT STACK	
	CM		INCHES				KG	LBS	KG	LBS
VS-S33	155.4	150.1	187.9	61.2	59.1	74	292	642	72	160
VS-S33P	155.4	150.1	187.9	61.2	59.1	74	334	735	104	230
VS-S33H	155.4	150.1	187.9	61.2	59.1	74	331	729	104	230



DIVERGING SEATED ROW

Independent cable movement provides a user-defined path of motion and exercise variety • Adjustable chest pad accommodates users of all sizes • Rotating grips provide maximum comfort and ergonomic hand positioning throughout the range of motion • Integrated foot pegs provide added support during heavy lifts

	PRODUCT DIMENSIONS (L X W X H)						PRODUCT WEIGHT		WEIGHT STACK	
	CM		INCHES				KG	LBS	KG	LBS
VS-S34	137.8	99.4	160.8	54.2	39.1	63.3	214	471	72	160
VS-S34P	137.8	99.4	167.1	54.2	39.1	65.8	249	547	104	230
VS-S34H	137.8	99.4	160.8	54.2	39.1	63.3	246	541	104	230

*Products shown as Versa+



BICEPS CURL

Arm pad is angled for stability and limits unwanted shoulder movement during exercise • Optimized pivot location creates biomechanically correct range of motion

	PRODUCT DIMENSIONS (L X W X H)					PRODUCT WEIGHT		WEIGHT STACK		
	CM		INCHES			KG	LBS	KG	LBS	
VS-S40	121.8	127	160.8	48	50	63.3	216	475	68	150
VS-S40P	121.8	127	167.1	48	50	65.8	242	531	90	200
VS-S40H	121.8	127	160.8	48	50	63.3	239	525	90	200



TRICEPS PRESS

Rotating handles adapt to users of all sizes • Angled back pad reduces stress, improves stabilization and enhances comfort

	PRODUCT DIMENSIONS (L X W X H)					PRODUCT WEIGHT		WEIGHT STACK		
	CM		INCHES			KG	LBS	KG	LBS	
VS-S42	157.7	107.5	160.8	62.1	42.3	63.3	256	564	72	160
VS-S42P	157.7	107.5	167.1	62.1	42.3	65.8	291	640	104	230
VS-S42H	157.7	107.5	160.8	62.1	42.3	63.3	288	634	104	230



BACK EXTENSION

Multi-position foot placement accommodates a variety of users • Contoured back pad enhances comfort

	PRODUCT DIMENSIONS (L X W X H)						PRODUCT WEIGHT		WEIGHT STACK	
	CM		INCHES				KG	LBS	KG	LBS
VS-S52	133.5	126.4	160.8	52.6	49.8	63.3	227	500	72	160
VS-S52P	133.5	126.4	167.1	52.6	49.8	65.8	262	576	104	230
VS-S52H	133.5	126.4	160.8	52.6	49.8	63.3	259	570	104	230



ABDOMINAL

3-position design trains abdominals and obliques for added exercise variety and core rotation • Ergonomic back pad improves range of motion and enhances comfort

	PRODUCT DIMENSIONS (L X W X H)						PRODUCT WEIGHT		WEIGHT STACK	
	CM		INCHES				KG	LBS	KG	LBS
VS-S53	136.6	141.4	160.8	53.8	55.7	63.3	197	433	72	160
VS-S53P	136.6	141.4	167.1	53.8	55.7	65.8	232	509	104	230
VS-S53H	136.6	141.4	160.8	53.8	55.7	63.3	229	503	104	230

*Products shown as Versa+



LEG PRESS/CALF PRESS

One-handed start adjustment for ease of use • Gas-assisted foot platform provides smoother adjustments • Assistance handle and low step-over height offer easy access • Foot plate identifies user foot position with unique visual indicators

	PRODUCT DIMENSIONS (L X W X H)						PRODUCT WEIGHT		WEIGHT STACK	
	CM	INCHES		KG	LBS	KG	LBS	KG	LBS	
VS-S70	232.4	102.4	160.8	91.5	40.3	63.3	361	795	188	415
VS-S70P	232.4	102.4	167.1	91.5	40.3	65.8	364	801	188	415
VS-S70H	232.4	102.4	160.8	91.5	40.3	63.3	361	795	188**	415**



LEG EXTENSION

Angled seat and back pads encourage full quadriceps contraction • Self-adjusting tibia pad enhances comfort • Pivot location is clearly marked to encourage correct alignment • Back pad ratchets forward for easy adjustment from seated position

	PRODUCT DIMENSIONS (L X W X H)						PRODUCT WEIGHT		WEIGHT STACK	
	CM	INCHES		KG	LBS	KG	LBS	KG	LBS	
VS-S71	183.5	128.9	160.8	72.3	50.7	63.3	243	536	72	160
VS-S71P	183.5	128.9	167.1	72.3	50.7	65.8	278	612	104	230
VS-S71H	183.5	128.9	160.8	72.3	50.7	63.3	275	606	104	230



SEATED LEG CURL

Angled seat and unique pivot location encourage full hamstring contraction • Tibia pad and range-of-motion adjustments are easily accessible from seated position • Back pad ratchets forward for easy adjustment from seated position • Adjustable thigh pad provides stabilization during exercise

	PRODUCT DIMENSIONS (L X W X H)						PRODUCT WEIGHT		WEIGHT STACK	
	CM			INCHES			KG	LBS	KG	LBS
VS-S72	176.9	113.3	160.8	69.7	44.6	63.3	253	556	68	150
VS-S72P	176.9	113.3	167.1	69.7	44.6	65.8	278	612	90	200
VS-S72H	176.9	113.3	160.8	69.7	44.6	63.3	275	606	90	200



GLUTE

Adjustable chest pad accommodates users of all sizes • Low step-height stabilization platform allows for ease of use • Upright user position, contoured elbow pads and large foot pad enhance comfort

	PRODUCT DIMENSIONS (L X W X H)						PRODUCT WEIGHT		WEIGHT STACK	
	CM			INCHES			KG	LBS	KG	LBS
VS-S78	177.8	99.9	160.8	70	39.3	63.3	185	409	68	150
VS-S78P	177.8	99.9	167.1	70	39.3	65.8	188	415	68	150
VS-S78H	177.8	99.9	160.8	70	39.3	63.3	185	409	68**	150**

*Products shown as Versa+ **VS-S70 and VS-S78 come standard with heavy weight stack

VERSA DUALS /

MORE FUNCTION, LESS SPACE

The expanded versatility of our dual stations makes it easy to create a weight-training collection just right for your space, your budget and the people you serve. By mixing and matching a range of our two-in-one stations, you can make the most of your floor space while providing a complete strength training experience. Intuitive adjustment, incremental weight control and clearly illustrated placards make it easy for users of all ability levels to smoothly transition from one exercise to the next, while ergonomic design adds comfort to every workout. Choose from eight dual-station units, customize with weight stack options or our premium Versa+ package, and complete your offering with more Versa single-station units.







MULTI-PRESS

Designed for easy entry and exit • Smoothly transition between exercises with one simple adjustment • Dual-position hand grips allow for greater training variety • Elevated foot rests provide stability and comfort during heavy lifts • Reclined position offers greater lumbar support • Clearly indicated adjustments for ease of use

	PRODUCT DIMENSIONS (L X W X H)					PRODUCT WEIGHT		WEIGHT STACK		
	CM	INCHES				KG	LBS	KG	LBS	
VS-S131	154.3	157.2	199.9	60.7	61.9	78.7	236	520	72	160
VS-S131P	154.3	157.2	199.9	60.7	61.9	78.7	271	596	104	230
VS-S131H	154.3	157.2	199.9	60.7	61.9	78.7	268	590	104	230



REAR DELT / PEC FLY

Comfortable, oversized grips accommodate users of all sizes • Always forward-facing user position enhances comfort and ease of use • Wide motion for improved biomechanics and dual function

	PRODUCT DIMENSIONS (L X W X H)					PRODUCT WEIGHT		WEIGHT STACK		
	CM	INCHES				KG	LBS	KG	LBS	
VS-S22	150.5	169	160.8	59.2	66.5	63.3	224	492	68	150
VS-S22P	150.5	169	167.1	59.2	66.5	65.8	259	548	90	200
VS-S22H	150.5	169	160.8	59.2	66.5	63.3	256	542	90	200



LAT PULLDOWN / SEATED ROW

Thigh pad easily adjusts to provide stability and comfort • Elevated foot rests provide stability and comfort during heavy lifts • Stainless-steel cable guides provide added protection for lasting durability • Clearly indicated adjustments for ease of use

	PRODUCT DIMENSIONS (L X W X H)						PRODUCT WEIGHT		WEIGHT STACK	
	CM		INCHES				KG	LBS	KG	LBS
VS-S331	180.5	157.9	226.3	71.1	62.2	89.1	246	543	72	160
VS-S331P	180.5	157.9	226.3	71.1	62.2	89.1	281	619	104	230
VS-S331H	180.5	157.9	226.3	71.1	62.2	89.1	278	613	104	230



BICEPS / TRICEPS

Compact design minimizes floor space • Stainless-steel cable guides provide added protection for lasting durability • Large foot platform provides stability

	PRODUCT DIMENSIONS (L X W X H)						PRODUCT WEIGHT		WEIGHT STACK	
	CM		INCHES				KG	LBS	KG	LBS
VS-S401	166.6	124.7	226.2	65.6	49.1	89.1	214	472	68	150
VS-S401P	166.6	124.7	226.2	65.6	49.1	89.1	240	528	90	200
VS-S401H	166.6	124.7	226.2	65.6	49.1	89.1	237	522	90	200

*Products shown as Versa+



AB / LOW BACK

Angled seat and lumbar pad enhance user comfort • Multi-position foot placement accommodates a variety of users • Low handle positions offer easy entry and exit and provide stability • Clearly indicated adjustments for ease of use

	PRODUCT DIMENSIONS (L X W X H)					PRODUCT WEIGHT		WEIGHT STACK		
	CM	INCHES				KG	LBS	KG	LBS	
VS-S531	132.2	131.5	160.8	52.1	51.8	63.3	231	509	72	160
VS-S531P	132.2	131.5	167.1	52.1	51.8	65.8	266	585	104	230
VS-S531H	132.2	131.5	160.8	52.1	51.8	63.3	263	579	104	230



CHIN / DIP ASSIST

Multi-position pull-up handles for greater exercise variety • Ideally angled dip grips encourage proper wrist placement and muscle variation • Gas-assisted knee platform folds up for unassisted bodyweight exercises and training variety • Large, textured foot platforms provide easy entry and exit • Knee platform features a protective top pad for added training security • Integrated hard stop prevents knee pad disengagement • Clearly indicated adjustments for ease of use

	PRODUCT DIMENSIONS (L X W X H)					PRODUCT WEIGHT		WEIGHT STACK		
	CM	INCHES				KG	LBS	KG	LBS	
VS-S601	142.8	152.8	219.7	56.2	60.2	86.5	307	676	68**	150**
VS-S601P	142.8	152.8	219.7	56.2	60.2	86.5	310	682	68**	150**
VS-S601H	142.8	152.8	219.7	56.2	60.2	86.5	307	676	68**	150**



LEG EXTENSION / LEG CURL

Angled pads and ideal pivot location promote full muscle contraction and alignment for both exercises • Dual-action CAM enables a smooth transition between exercises and prevents cable slack • Adjustments are easily performed in the seated position • Back pad ratchets forward for easy adjustment from the seated position • Clearly indicated adjustments for ease of use

	PRODUCT DIMENSIONS (L X W X H)					PRODUCT WEIGHT		WEIGHT STACK		
	CM	INCHES				KG	LBS	KG	LBS	
VS-S711	177.6	118.3	160.8	69.9	46.6	63.3	251	554	72	160
VS-S711P	177.6	118.3	167.1	69.9	46.6	65.8	286	630	104	230
VS-S711H	177.6	118.3	160.8	69.9	46.6	63.3	283	624	104	230



HIP ADDUCTOR / ABDUCTOR

Dual-function machine saves space and increases functionality • Reclined position provides greater comfort • Clearly indicated adjustments allow for ease of use

	PRODUCT DIMENSIONS (L X W X H)					PRODUCT WEIGHT		WEIGHT STACK		
	CM	INCHES				KG	LBS	KG	LBS	
VS-S74	169.6	159.1	160.8	66.8	62.6	63.3	235	516	72	160
VS-S74P	169.6	159.1	167.1	66.8	62.6	65.8	269	592	104	230
VS-S74H	169.6	159.1	160.8	66.8	62.6	63.3	266	586	104	230

*Products shown as Versa+ **VS-601 comes standard with heavy weight stack

MD LEG PRESS

Ideal for creating a wide range of progression programs, including isometric, loaded isometric, isotonic, plyometric, elastic and combined (elastic and weight stack) exercises • Low starting weight offers gradual progression • Adjustable shoulder pads and gas-assisted seat back provide flexible progressions and comfortable use for clients of all sizes • Stack disconnect allows free movement of the carriage without additional resistance, ideal for deconditioned and injured clients • Band hooks make it easy to add external resistance bands for elastic and plyometric training • Carriage lockout and range-of-motion limiter restrict carriage movement for isometric contractions while protecting clients from overextending • Also available: optional incremental weights, step stool, force plate holder and accessory package



WEDGE BLOCK / HEEL CUP / ACCESSORY CRADLE

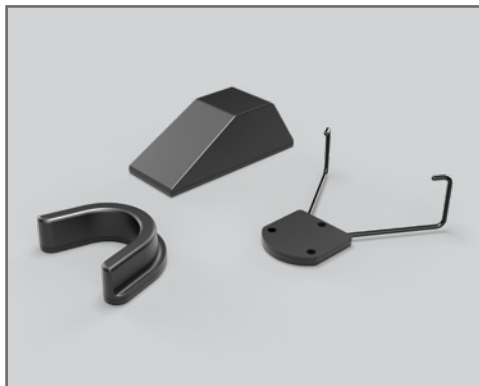

* Optional MD-S70-AP Accessory Package

	PRODUCT DIMENSIONS (L X W X H)						PRODUCT WEIGHT		WEIGHT STACK	
	CM	INCHES	CM	INCHES	CM	INCHES	KG	LBS	KG	LBS
MD-S70	263.2	121.9	188.3	103.7	48	74.2	372	820	136	300



MD LEG EXTENSION / CURL

Ideal for creating a wide range of progression programs including exercises that build strength in the hamstrings and quads • Unique seat pivot allows proper joint alignment creating optimal biomechanics in both directions • Gas-assisted adjustments combined with a rotating thigh pad for open exit and entry provide an exceptional user experience • The range-of-motion limiter and 12 starting positions allow complete control over stroke length and isometric contractions • Low starting weight of 4.5 kg / 10 lbs. for the leg extension and 3.4 kg / 7.5 lbs. for the leg curl • Also available: optional incremental weights and step stool

	PRODUCT DIMENSIONS (L X W X H)						PRODUCT WEIGHT		WEIGHT STACK	
	CM		INCHES				KG	LBS	KG	LBS
MD-S711	165.4	125.4	162.5	65.2	49.4	64	340	750	91	200



MD ADJUSTABLE PULLEY

Ideal for creating a wide range of progression programs including exercises that build upper body, lower body and core muscles that are essential to ADLs • 35 clearly numbered adjustment points provide exercise variety • Low starting weight of 2.3 kg / 5 lbs. offers gradual progression • 1:2 pulley ratio provides smooth operation • Also available: optional incremental weight, balance bar, medical handrail, wheel transport and Inclusive Fitness kit

	PRODUCT DIMENSIONS (L X W X H)						PRODUCT WEIGHT		WEIGHT STACK	
	CM		INCHES				KG	LBS	KG	LBS
MD-AP	107.2	125	228	42.2	49.3	89.8	174	384	68	150

**Products shown with optional accessories.*

VERSA FUNCTIONAL TRAINER /

SPACE-SAVING VERSATILITY

The smart design of our functional trainer provides a remarkable range of exercise options in a space-saving footprint. Incremental weight adjustment and a 1:2 pulley ratio make it easy to control exercise intensity and create progressions right for everyone from deconditioned users to elite athletes. Everything about our functional trainer — from the multi-grip pull-up bar to the color-coded adjustment points to the professionally illustrated exercise placards — offers intuitive operation for users and trainers alike. Optional storage makes it easy to organize and stow accessories for instant access, and the completely enclosed design protects the unit's moving parts while creating a solid, cohesive aesthetic on your floor.





FUNCTIONAL TRAINER

Multi-position pull-up handles for greater exercise variety • Fully enclosed weight stacks protect the machine's internal components • Enhanced placards highlight targeted muscle groups and proper user positioning for a wide range of exercises • One-handed pulley adjustment offers easy operation • Frame guards protect against chips and scratches • Clearly indicated adjustments for ease of use • Compact design accommodates placement in spaces with ceilings as low as 2.4 m / 8' • 76 cm / 30" connection provides ample storage for functional training accessories • 1:2 pulley ratio provides smooth operation • Standard effective resistance 34 kg / 75 lbs. (per side) • Also available: VS-VFT-S18 Functional Trainer with 46 cm / 18" connection to accommodate optional training handles • Optional: VS-VFT60 heavy stack for added 13.6 kg / 30 lbs. of resistance per side for 47.6 kg / 105 lbs. effective resistance • Optional accessory: VS-FTHP handle package includes four training handles (v-bar, curl bar, ropes, ankle strap) • Optional: VS-FTIW 2.3 kg / 5 lb. increment weight (effective resistance 1.1 kg / 2.5lb.)

	PRODUCT DIMENSIONS (L X W X H)					PRODUCT WEIGHT		WEIGHT STACK		
	CM		INCHES			KG	LBS	KG	LBS	
VS-VFT-S18	111.8	160.0	237.6	44.0	63	93.5	355	782	68	150
VS-VFT-S30	122.7	145.8	237.6	48.3	57.4	93.5	369	814	68	150
VS-VFT-S18 + VS-VFT60	111.8	160.0	237.6	44.0	63	93.5	409	902	95	210
VS-VFT-S30 + VS-VFT60	122.7	145.8	237.6	48.3	57.4	93.5	424	934	95	210

*Accessories not included.

VERSA STANDARD FRAME AND UPHOLSTERY COLORS

Iced Silver frames

Obsidian Black – Upholstery



Clay Red – Upholstery



Slate Blue – Upholstery



Matte Black frames

Obsidian Black – Upholstery



Clay Red – Upholstery

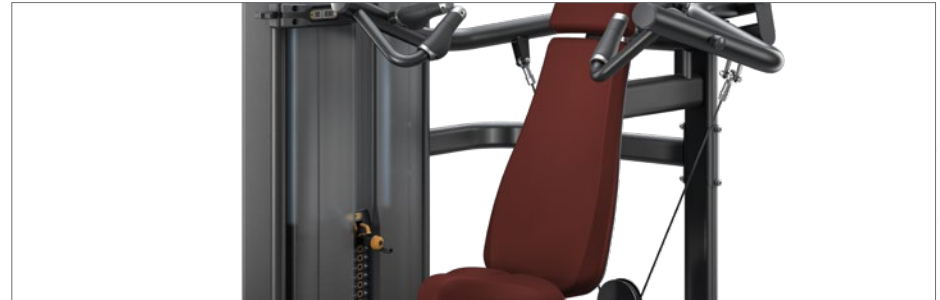

Slate Blue – Upholstery



NOTE: All specifications are subject to change without notice. Actual products may differ from those pictured in this catalog. Actual product colors may vary from what is shown here.



ChestPress
MATRIX

MATRIX

Shoulder Press
MATRIX

AURA SERIES /

THE STANDARD IN PERFORMANCE AND DESIGN



AURA SERIES /

A superior blend of features and sophistication, the Aura Series appeals to fitness enthusiasts of all kinds. Independent converging and diverging motions on select units provide a natural resistance movement that feels smooth and natural. Ergo Form cushions ensure proper body alignment and support while introducing an extra touch of style. In addition to offering a unique aesthetic distinction that attracts users, our round-tube construction with automotive-quality powder-coat finish provides lasting strength and durability.



Frame and Finish Attractive round-tube construction provides unmatched strength, and automotive-quality finish is highly resistant to chips and scratches. **Bottle and Towel Holder** Conveniently positioned to prevent spills and clutter on your floor. **Color-Coded Exercise Placards** Easy-to-read reference cards highlight targeted muscle groups and proper machine use. **Ergo Form Cushions** Uniquely attractive design ensures proper body alignment and support. **Incremental Weights** Easy to access and reference from the seated position. **Converging/Diverging Motion** Encourages a natural path of motion to enhance comfort.





CHEST PRESS

Adjustable pressing arm allows users to determine their own range of motion • Oversized, dual-position hand grips provide greater comfort and variety

	PRODUCT DIMENSIONS (L X W X H)						PRODUCT WEIGHT		WEIGHT STACK	
	CM		INCHES				KG	LBS	KG	LBS
G3-S10	127	155.9	184.7	50	61.4	72.7	275	607	113	250



PECTORAL FLY

Dual hand grips accommodate users of all sizes • Independent arm action ensures more balanced exercise by not allowing the dominant side to control the exercise • Adjustable starting position allows for greater range of motion

	PRODUCT DIMENSIONS (L X W X H)						PRODUCT WEIGHT		WEIGHT STACK	
	CM		INCHES				KG	LBS	KG	LBS
G3-S12	113.3	156.8	150.6	44.6	61.7	59.3	246	542	91	200



CONVERGING CHEST PRESS

Independent converging motion arms • Dual hand-grip positions provide greater training variety • Designed for easy entry and exit

	PRODUCT DIMENSIONS (L X W X H)						PRODUCT WEIGHT		WEIGHT STACK	
	CM		INCHES				KG	LBS	KG	LBS
G3-S13	128.3	155.1	174.8	50.5	61.1	68.8	293	645	113	250



SHOULDER PRESS

Dual-position hand grips allow for greater training variety • Oversized hand grips provide improved function and comfort • Counterbalanced pressing arm provides reduced starting resistance

	PRODUCT DIMENSIONS (L X W X H)						PRODUCT WEIGHT		WEIGHT STACK	
	CM		INCHES				KG	LBS	KG	LBS
G3-S20	152	146.9	150.7	59.8	57.8	59.3	251	553	91	200



LATERAL RAISE

Independent arm action ensures balanced exercise • Handles pivot to accommodate users of all sizes

	PRODUCT DIMENSIONS (L X W X H)						PRODUCT WEIGHT		WEIGHT STACK	
	CM			INCHES			KG	LBS	KG	LBS
G3-S21	154.2	152.4	150.6	60.7	60	59.3	271	597	91	200



REAR DELT / FLY

User arms pivot to accommodate individual forearm lengths and varying paths of motion • Optimized handle positions reduce the need to adjust the seat position between rear deltoid and fly exercises

	PRODUCT DIMENSIONS (L X W X H)						PRODUCT WEIGHT		WEIGHT STACK	
	CM			INCHES			KG	LBS	KG	LBS
G3-S22	136.8	191.6	204.3	53.9	75.4	80.4	294	648	134	295



CONVERGING SHOULDER PRESS

Independent converging motion arms • Pressing arm includes both standard and neutral grips for user preference • Oversized hand grips provide greater comfort and variety

	PRODUCT DIMENSIONS (L X W X H)						PRODUCT WEIGHT		WEIGHT STACK	
	CM		INCHES				KG	LBS	KG	LBS
G3-S23	153.8	149.3	173.6	60.6	58.8	68.4	251	553	91	200



LAT PULLDOWN

Thigh pads easily adjust to provide both stability and comfort • Straight bar with angled ends ensures correct arm and wrist position throughout the entire range of motion

	PRODUCT DIMENSIONS (L X W X H)						PRODUCT WEIGHT		WEIGHT STACK	
	CM		INCHES				KG	LBS	KG	LBS
G3-S30	146.4	119.6	221.7	57.6	47.1	87.3	250	551	134	295



SEATED ROW

Dual-position hand grips allow for greater training variety • Optimized pivot location creates a biomechanically correct arc of motion

	PRODUCT DIMENSIONS (L X W X H)						PRODUCT WEIGHT		WEIGHT STACK	
	CM			INCHES			KG	LBS	KG	LBS
G3-S31	151.4	92.1	210.6	59.6	36.3	82.9	273	601	113	250



DIVERGING LAT PULLDOWN

Independent diverging motion arms • Angled seat cues optimal user position • High pads easily adjust to provide both stability and comfort

	PRODUCT DIMENSIONS (L X W X H)						PRODUCT WEIGHT		WEIGHT STACK	
	CM			INCHES			KG	LBS	KG	LBS
G3-S33	146.7	88.4	211.7	57.8	34.8	83.3	237	527	113	250



DIVERGING SEATED ROW

Independent diverging motion arms • Dual-position hand grips provide greater training variety

	PRODUCT DIMENSIONS (L X W X H)						PRODUCT WEIGHT		WEIGHT STACK	
	CM		INCHES				KG	LBS	KG	LBS
G3-S34	154.4	87.9	198.7	60.8	34.6	78.2	259	570	113	250



ARM CURL

Arm pad is angled for stability and limits unwanted shoulder movement during exercise • Angled rotating hand grips ensure optimal wrist position

	PRODUCT DIMENSIONS (L X W X H)						PRODUCT WEIGHT		WEIGHT STACK	
	CM		INCHES				KG	LBS	KG	LBS
G3-S40	122	108.6	150.6	48.1	42.8	59.3	228	502	91	200



TRICEPS PRESS

Rotating handles adapt to users of all sizes • Over-molded grips ensure a secure, non-slip feel • Angled back pad reduces stress, improves stabilization and enhances comfort

	PRODUCT DIMENSIONS (L X W X H)						PRODUCT WEIGHT		WEIGHT STACK	
	CM		INCHES				KG	LBS	KG	LBS
G3-S42	158.8	128	173.6	62.5	50.4	68.4	261	575	91	200



TRICEPS EXTENSION

Seat and upper-arm pads are angled to enhance user stability during exercise • Handle pivots adjust for varying forearm lengths

	PRODUCT DIMENSIONS (L X W X H)						PRODUCT WEIGHT		WEIGHT STACK	
	CM		INCHES				KG	LBS	KG	LBS
G3-S45	117.4	108.4	150.6	46.2	42.7	59.3	223	491	91	200



ABDOMINAL

Hand grips and contoured-edge chest pad enhance comfort • Adjustable resistance arm allows users to determine their own starting positions

	PRODUCT DIMENSIONS (L X W X H)						PRODUCT WEIGHT		WEIGHT STACK	
	CM	INCHES					KG	LBS	KG	LBS
G3-S50	137	94	150	54	37	59	184	405	68	150



ABDOMINAL CRUNCH

Dual axis of rotation enhances user feel for a natural crunch movement and muscle contraction • Seat and handle positions enhance user stability

	PRODUCT DIMENSIONS (L X W X H)						PRODUCT WEIGHT		WEIGHT STACK	
	CM	INCHES					KG	LBS	KG	LBS
G3-S51	142.8	112.2	150.5	56.2	44.2	59.3	184	405	91	200



BACK EXTENSION

Adjustable nonskid footrests provide secure and proper positioning • Lower-back reference pad encourages proper user alignment

	PRODUCT DIMENSIONS (L X W X H)						PRODUCT WEIGHT		WEIGHT STACK	
	CM		INCHES				KG	LBS	KG	LBS
G3-S52	157.7	106.5	174.9	62.1	41.9	68.9	277	610	134	295



ROTARY TORSO

Unique design reinforces proper user positioning • Range of motion is adjustable in 10-degree increments • Foot bar helps users of all sizes achieve proper stabilization

	PRODUCT DIMENSIONS (L X W X H)						PRODUCT WEIGHT		WEIGHT STACK	
	CM		INCHES				KG	LBS	KG	LBS
G3-S55	164.2	97	173.7	64.6	38.2	68.4	216	476	91	200



DIP / CHIN ASSIST

Rotating dip handles adapt to users of all sizes • Pull-up bar offers both standard and neutral grips for individual preference • 2 sets of pull-up grips allow users of all heights a full range of motion

	PRODUCT DIMENSIONS (L X W X H)						PRODUCT WEIGHT		WEIGHT STACK	
	CM		INCHES				KG	LBS	KG	LBS
G3-S60	117.6	121.8	230.7	46.3	47.9	90.8	229	505	68	150





LEG PRESS

4-bar linkage enhances alignment and provides variable resistance • Large nonskid footplate accommodates users of all sizes

	PRODUCT DIMENSIONS (L X W X H)						PRODUCT WEIGHT		WEIGHT STACK	
	CM		INCHES				KG	LBS	KG	LBS
G3-S70	210.1	124.6	184.6	82.7	49	72.7	417	920	175	385



LEG EXTENSION

Angled seat and back pads encourage full quadriceps contraction • Adjustable start position facilitates increased range of motion • Self-adjusting tibia pad enhances comfort

	PRODUCT DIMENSIONS (L X W X H)						PRODUCT WEIGHT		WEIGHT STACK	
	CM		INCHES				KG	LBS	KG	LBS
G3-S71	178.9	109.4	173.6	70.4	43.1	68.4	265	584	113	250



SEATED LEG CURL

Seat, back and tibia pads adjust without affecting knee alignment or start-position angle • Adjustable start position facilitates increased range of motion

	PRODUCT DIMENSIONS (L X W X H)						PRODUCT WEIGHT		WEIGHT STACK	
	CM		INCHES				KG	LBS	KG	LBS
G3-S72	178.9	109.4	173.6	70.4	43.1	68.4	257	566	93	205



PRONE LEG CURL

Divergent pad angle eliminates lower-back stress • Standard range of motion adjusts for individual preference

	PRODUCT DIMENSIONS (L X W X H)						PRODUCT WEIGHT		WEIGHT STACK	
	CM		INCHES				KG	LBS	KG	LBS
G3-S73	177.5	111.7	173.6	69.9	44	68.3	272	600	91	200



HIP ADDUCTOR

Knee pads and dual footrests provide leg support and enhanced comfort • Weight stack positioned in front of the user acts as a shield, providing enhanced privacy

	PRODUCT DIMENSIONS (L X W X H)						PRODUCT WEIGHT		WEIGHT STACK	
	CM		INCHES				KG	LBS	KG	LBS
G3-S74	166.6	164.3	150.8	65.6	64.7	59.4	264	582	100	220



HIP ABDUCTOR

Knee pads and dual footrests provide leg support to eliminate unwanted torque around the knee • Weight stack positioned in front of the user acts as a shield, providing enhanced privacy

	PRODUCT DIMENSIONS (L X W X H)						PRODUCT WEIGHT		WEIGHT STACK	
	CM		INCHES				KG	LBS	KG	LBS
G3-S75	166.6	107.5	150.8	65.6	42.3	59.4	270	595	100	220



ROTARY HIP

Standing position provides enhanced alignment and increased target muscle involvement • Adjustable carriage allows users of varying heights to achieve optimal positioning • Starting positions are incremental at 15-degree intervals through 270 degrees of rotation • Low step-up height 13.2 cm / 5.2" for easy entry and exit

	PRODUCT DIMENSIONS (L X W X H)						PRODUCT WEIGHT		WEIGHT STACK	
	CM	INCHES		KG	LBS	KG	LBS	KG	LBS	
G3-S76	111.7	119.7	184.3	44	47.1	72.6	295	650	134	295



CALF PRESS

Force is transmitted through hips to eliminate spinal compression • Footplates are curved for comfortable positioning and a full range of motion • Fully enclosed linear bearings provide smooth, quiet motion

	PRODUCT DIMENSIONS (L X W X H)						PRODUCT WEIGHT		WEIGHT STACK	
	CM	INCHES		KG	LBS	KG	LBS	KG	LBS	
G3-S77	173	68.9	150.5	68.1	27.1	59.3	304	670	134	295



FUNCTIONAL TRAINER

1:4 pulley ratio offers low starting resistance and high-speed movements • Available with 132-kg / 290-lb. or 177-kg / 390-lb. stacks • Standard swiveling accessory station includes 10 attachments • Multi-grip-position pull-up handles with unique rock-climbing attachment • Integrated fold-away step offers easy access • G3-MSFT300 effective resistance: 32.9-kg / 72.5-lbs. (per side) • G3-MSFT400 effective resistance: 44.2-kg / 97.5-lbs. (per side)

	PRODUCT DIMENSIONS (L X W X H)						PRODUCT WEIGHT		WEIGHT STACK	
	CM		INCHES				KG	LBS	KG	LBS
G3-MSFT300	169.2	130.2	234.4	66.6	51.2	92.3	601	1324	2 X 131	2 X 290
G3-MSFT400	169.2	130.2	234.4	66.6	51.2	92.3	697	1537	2 X 176	2 X 390



Flanged pulley housing



ADJUSTABLE CABLE CROSSOVER

Widely spaced, dual-adjustable pulleys offer exercise variety • Pull-up bar with both lat and neutral grips provide hand placement options • One-handed adjustment makes operation easy • Flanged pulley housing minimizes cable wear and increases durability • 1:2 pulley ratio provides smooth operation

	PRODUCT DIMENSIONS (L X W X H)						PRODUCT WEIGHT		WEIGHT STACK	
	CM	INCHES	KG	LBS	KG	LBS	KG	LBS		
G3-MS20	397.4	90	239.6	156.5	35.4	94.3	399	880	2 X 91	2 X 200



5-STACK MULTI-STATION

	PRODUCT DIMENSIONS (L X W X H)						PRODUCT WEIGHT		WEIGHT STACK	
	CM		INCHES				KG	LBS	KG	LBS
G3-MS50	481.5	369.8	251.7	189.6	145.6	99.1	1197	2640	3 X 91 2 X 134	3 X 200 2 X 295



4-STACK MULTI-STATION

	PRODUCT DIMENSIONS (L X W X H)						PRODUCT WEIGHT		WEIGHT STACK	
	CM			INCHES			KG	LBS	KG	LBS
G3-MS40	167.8	369.8	252	66.1	145.6	99.2	998	2200	2 X 91 2 X 134	2 X 200 2 X 295

ADJUSTABLE PULLEY

Single-handed height adjustment offers easy use • 1:2 pulley ratio provides smooth movement and smaller incremental weight changes • Balance bar adds support during exercise • Includes water bottle holder and towel hook • Modular design is easily customized to your space



	PRODUCT DIMENSIONS (L X W X H)						PRODUCT WEIGHT		WEIGHT STACK	
	CM			INCHES			KG	LBS	KG	LBS
G3-MS24	68	70	240	27	28	94.5	181	398.5	91	200

LAT PULLDOWN

Two independent cables add training variety • Pivoting knee pad allows for quick and easy adjustments • Includes water bottle holder and towel hook • Modular design is easily customized to your space



	PRODUCT DIMENSIONS (L X W X H)						PRODUCT WEIGHT		WEIGHT STACK	
	CM			INCHES			KG	LBS	KG	LBS
G3-MS51	140	120	252	55	47.5	99.5	252	556	134	295



8-STACK MULTI-STATION

	PRODUCT DIMENSIONS (L X W X H)						PRODUCT WEIGHT		WEIGHT STACK	
	CM			INCHES			KG	LBS	KG	LBS
G3-MS80	561.3	370.9	251.7	221	146	99.1	1996	4400	4 X 91 4 X 134	4 X 200 4 X 295

TRICEPS PRESSDOWN

Swiveling top pulley enhances durability • 1:1 pulley ratio allows for heavy training • Additional stability pad enhances comfort • Includes water bottle holder and towel hook • Modular design is easily customized to your space



	PRODUCT DIMENSIONS (L X W X H)						PRODUCT WEIGHT		WEIGHT STACK	
	CM			INCHES			KG	LBS	KG	LBS
G3-MS52	85	59	240	33.5	23.5	94.5	171.5	377.5	91	200

LOW ROW

Two independent cables add training variety • Pivoting knee pad allows for quick and easy adjustments • Includes water bottle holder and towel hook • Modular design is easily customized to your space



	PRODUCT DIMENSIONS (L X W X H)						PRODUCT WEIGHT		WEIGHT STACK	
	CM			INCHES			KG	LBS	KG	LBS
G3-MS53	230	71	240	91	28	94.5	260	573	134	295

AURA STANDARD FRAME AND UPHOLSTERY COLORS

Iced Silver frames

Obsidian Black – Upholstery



Clay Red – Upholstery



Slate Blue – Upholstery



Matte Black frames

Obsidian Black – Upholstery



Clay Red – Upholstery



Slate Blue – Upholstery

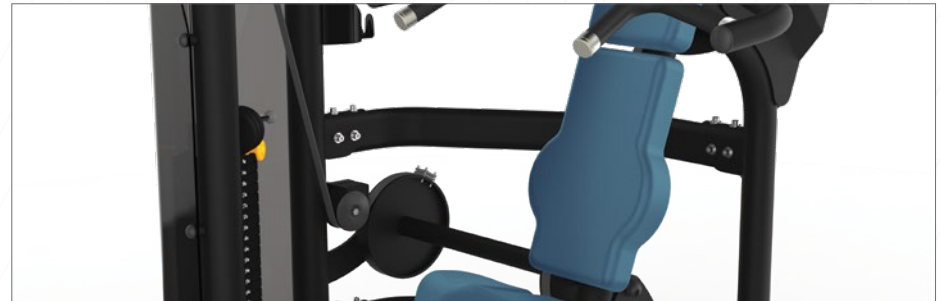

NOTE: All specifications are subject to change without notice. Actual products may differ from those pictured in this catalog. Actual product colors may vary from what is shown here.



GO SERIES /

DISCOVER THE STRENGTH OF SIMPLICITY



GO SERIES /

Ideal for users new to strength training and circuit programs, Go Series single stations are compact and easy-to-use — creating a welcoming experience.



Enhanced Usability Minimal adjustments, low starting weight and optional incremental weight allows for smaller progressions that keep users of all abilities motivated as they gain strength. **Space-saving Design** Compact footprint with back-to-back configurations improves traffic flow and helps you serve more users when space is at a premium and budgets need to stretch further. **User Amenities** Storage space on top of stack lets users keep their personal device, water bottle and towel in reach while reducing clutter on your floor. **Exercise Placards** Large, easy-to-read reference cards highlight targeted muscle groups and proper machine use. **Streamlined Service & Maintenance** Guide rods can be removed without any tools, while a durable metal shroud withstands tough environments and can be easily removed to streamline service.





CHEST PRESS

Oversized neutral grips provide a natural, comfortable hold that reduces stress on shoulder joints • Intuitive design with no adjustments needed

	PRODUCT DIMENSIONS (L X W X H)						PRODUCT WEIGHT		WEIGHT STACK	
	CM			INCHES			KG	LBS	KG	LBS
GO-S13	158	118	137	62.2	46.6	54	166	366	72	160



SHOULDER PRESS

Intuitive design with no adjustments needed • Oversized neutral grips provide a natural, comfortable hold that reduces stress on shoulder joints

	PRODUCT DIMENSIONS (L X W X H)						PRODUCT WEIGHT		WEIGHT STACK	
	CM			INCHES			KG	LBS	KG	LBS
GO-S23	148	110.5	176	58.4	43.5	69.3	160	353	45	100



LAT PULLDOWN

Ratcheting seat adjusts easily, letting users fine tune the range of motion for optimal comfort and function • Oversized neutral grips offer a comfortable hold while reducing stress on shoulder joints

	PRODUCT DIMENSIONS (L X W X H)						PRODUCT WEIGHT		WEIGHT STACK	
	CM		INCHES				KG	LBS	KG	LBS
GO-S33	174	91	171	68.5	35.8	67.3	210	463	72	160



SEATED ROW

Oversized angled grips provide a natural, comfortable hold • Dual position foot pegs and an extra-long seat let users of different heights position themselves comfortably with no adjustments needed

	PRODUCT DIMENSIONS (L X W X H)						PRODUCT WEIGHT		WEIGHT STACK	
	CM		INCHES				KG	LBS	KG	LBS
GO-S34	148	123	137	58.3	48.5	54	159	350.5	72	160



BICEPS CURL

Intuitive design with no adjustments needed • Highlighted pivot point indicates optimal elbow positioning and body alignment • Extended seat lets users shift hip positioning for proper alignment

	PRODUCT DIMENSIONS (L X W X H)						PRODUCT WEIGHT		WEIGHT STACK	
	CM		INCHES				KG	LBS	KG	LBS
GO-S40	125	104	137	49.2	41	54	148	326.5	54	120



SEATED TRICEPS PRESS

Oversized neutral grips provide a natural, comfortable hold • Seated press motion follows a natural path, reducing stress on elbow joints, engaging the entire upper body and aiding in sit-to-stand progressions • Intuitive design with no adjustments needed

	PRODUCT DIMENSIONS (L X W X H)						PRODUCT WEIGHT		WEIGHT STACK	
	CM		INCHES				KG	LBS	KG	LBS
GO-S42	130.5	101.5	137	51.4	39.9	54	163	359.5	72	160



ABDOMINAL

Intuitive design with no adjustments needed • Comfortably contoured back pad provides a full range of motion, stretching core muscles in a way traditional flat back pads can't • Soft, oversized grips offer a comfortable hold

	PRODUCT DIMENSIONS (L X W X H)						PRODUCT WEIGHT		WEIGHT STACK	
	CM		INCHES				KG	LBS	KG	LBS
GO-S53	158	94.5	137	62.2	37.2	54	150.5	332	63	140



LEG PRESS

Low step-in height offers easy entry and exit • Clearly numbered adjustment points make each user's starting point easily identifiable and repeatable for faster starts • Large rubber foot platform with a textured surface offers comfortable, secure foot placement for a wide range of users

	PRODUCT DIMENSIONS (L X W X H)						PRODUCT WEIGHT		WEIGHT STACK	
	CM	INCHES					KG	LBS	KG	LBS
GO-S70	101	183.5	137	39.7	72.3	54	246	542.4	95	210



LEG EXTENSION

Extra-large seat offers comfortable support for users and faster transitions in and out of the unit • Self-adjusting tibia pad provides greater ease of use • Adjustable range of motion lets users with different degrees of knee mobility build strength

	PRODUCT DIMENSIONS (L X W X H)						PRODUCT WEIGHT		WEIGHT STACK	
	CM	INCHES					KG	LBS	KG	LBS
GO-S71	132	130	137	52	51.3	54	178	392.5	72	160



SEATED LEG CURL

Self-adjusting ankle pad provides greater ease of use • Adjustable range of motion lets users with different degrees of hamstring mobility build strength • Extra-large seat offers comfortable support for users and faster transitions in and out of the unit

	PRODUCT DIMENSIONS (L X W X H)						PRODUCT WEIGHT		WEIGHT STACK	
	CM	INCHES					KG	LBS	KG	LBS
GO-S72	128	109	137	50.5	43	54	198	436.5	54	120

GO SERIES STANDARD FRAME AND UPHOLSTERY COLORS

Iced Silver frames

Obsidian Black – Upholstery



Clay Red – Upholstery



Slate Blue – Upholstery



Matte Black frames

Obsidian Black – Upholstery



Clay Red – Upholstery



Slate Blue – Upholstery



NOTE: All specifications are subject to change without notice. Actual products may differ from those pictured in this catalog. Actual product colors may vary from what is shown here.



MAGNUM SERIES /

A LEGACY OF PERFORMANCE AND PROVEN DURABILITY



MAGNUM SERIES /

Ideal for helping professional athletes reach their ultimate potential, the Magnum Series provides an unparalleled blend of performance and durability. Simple, exclusive Breaker Benches allow users to get into the start position with less stress on their joints. Other products like Double MEGA Racks pack in the functionality to help you make the most of your floor space. Best of all, everything that carries the Magnum Series name will withstand the most intense training environments.



Durable Construction Built to withstand the rigorous strength training of professional sports teams.

Converging/Diverging Motion Encourages a natural path of motion to enhance comfort. **Ergonomics and Biomechanics** Designed for comfort while providing a natural, mechanically correct motion.

Color-coded Adjustment Points Conveniently located and clearly marked for easy use. **Frame Finish** Automotive-quality finish is highly resistant to chips and scratches. **Variety** A robust selection meets the training needs of virtually any facility.



BREAKER BENCHES /

EASIER TAKEOFFS

Incredibly beneficial for beginners and professional athletes alike, this exclusive system uses pivoting uprights to place the bar directly over the user. We call them Breaker Benches because they eliminate the need for assistance to break the bar, allowing users to get into the start position with less stress on their joints. Greater comfort, easier takeoffs and increased efficiency add up to a superior solution for all users in resistance training.





BREAKER OLYMPIC FLAT BENCH

Uprights pivot forward into ideal starting position, directly over the user for easy takeoff • Molded urethane guards protect Olympic bars from damage, reduce noise and provide a hand rest for spotters • Wide back pad stabilizes users during heavy lifts • 10 weight-storage horns (20-kg / 45-lb. plates store at waist height) • Designed to meet EN957 and ASTM safety standards • Shown with optional spotter platform (MG-AOSP)

	PRODUCT DIMENSIONS (L X W X H)						PRODUCT WEIGHT	
	CM			INCHES			KG	LBS
MG-A678	173	168	130	68	66	51	94	207



OLYMPIC FLAT BENCH

Molded urethane guards protect Olympic bars from damage, reduce noise and provide a hand rest for spotters • Wide back pad stabilizes users during heavy lifts • 10 weight-storage horns (20-kg / 45-lb. plates store at waist height) • Designed to meet EN957 and ASTM safety standards • Shown with optional spotter platform (MG-AOSP)

	PRODUCT DIMENSIONS (L X W X H)						PRODUCT WEIGHT	
	CM			INCHES			KG	LBS
MG-A78	163	168	130	64	66	51	73	160



BREAKER OLYMPIC INCLINE BENCH

Uprights pivot forward into ideal starting position, directly over the user for easy takeoff • Molded urethane guards protect Olympic bars from damage, reduce noise and provide a hand rest for spotters • Wide back pad stabilizes users during heavy lifts • Ratcheting seat design for ease of use and adjustment • 10 weight-storage horns (20-kg / 45-lb. plates store at waist height) • Comes standard with built-in spotter platform • Designed to meet EN957 and ASTM safety standards

	PRODUCT DIMENSIONS (L X W X H)						PRODUCT WEIGHT	
	CM			INCHES			KG	LBS
MG-A679	170	168	160	67	66	63	126	277



OLYMPIC INCLINE BENCH

Molded urethane guards protect Olympic bars from damage, reduce noise and provide a hand rest for spotters • Wide back pad stabilizes users during heavy lifts • Ratcheting seat design for ease of use and adjustment • 10 weight-storage horns (20-kg / 45-lb. plates store at waist height) • Comes standard with built-in spotter platform • Designed to meet EN957 and ASTM safety standards

	PRODUCT DIMENSIONS (L X W X H)						PRODUCT WEIGHT	
	CM			INCHES			KG	LBS
MG-A79	170	168	160	67	66	63	107	235

BREAKER OLYMPIC DECLINE BENCH



Uprights pivot forward into ideal starting position, directly over the user for easy takeoff • Molded urethane guards protect Olympic bars from damage, reduce noise and provide a hand rest for spotters • 10 weight-storage horns (20-kg / 45-lb. plates store at waist height) • Wide back pad stabilizes users during heavy lifts • Designed to meet EN957 and ASTM safety standards • Knee and ankle pads easily pivot to accommodate all user sizes

	PRODUCT DIMENSIONS (L X W X H)						PRODUCT WEIGHT	
	CM			INCHES			KG	LBS
MG-A680	206	168	135	81	66	53	107	235

OLYMPIC DECLINE BENCH



Molded urethane guards protect Olympic bars from damage, reduce noise and provide a hand rest for spotters • 10 weight-storage horns (20-kg / 45-lb. plates store at waist height) • Wide back pad stabilizes users during heavy lifts • Designed to meet EN957 and ASTM safety standards • Knee and ankle pads easily pivot to accommodate all user sizes

	PRODUCT DIMENSIONS (L X W X H)						PRODUCT WEIGHT	
	CM			INCHES			KG	LBS
MG-A80	201	168	137	79	66	54	82	180

BREAKER OLYMPIC SHOULDER BENCH



Uprights pivot forward into ideal starting position, directly over the user for easy takeoff • Molded urethane guards protect Olympic bars from damage, reduce noise and provide a hand rest for spotters • Comes standard with built-in spotter platform • 10 weight-storage horns (20-kg / 45-lb. plates store at waist height) • Designed to meet EN957 and ASTM safety standards

	PRODUCT DIMENSIONS (L X W X H)						PRODUCT WEIGHT	
	CM			INCHES			KG	LBS
MG-A645	135	138	183	53	66	72	118	260

OLYMPIC SHOULDER BENCH



Front and rear takeoffs connected with bottom stop bar • Molded urethane guards protect Olympic bars from damage, reduce noise and provide a hand rest for spotters • Comes standard with built-in spotter platform • 10 weight-storage horns (20-kg / 45-lb. plates store at waist height) • Designed to meet EN957 and ASTM safety standards

	PRODUCT DIMENSIONS (L X W X H)						PRODUCT WEIGHT	
	CM			INCHES			KG	LBS
MG-A45	127	138	165	50	66	65	137	303



3-WAY OLYMPIC BENCH

Molded urethane guards protect Olympic bars from damage, reduce noise and provide a hand rest for spotters • Flat bench press, incline press and shoulder press can all be performed with simple adjustments • Easy-to-use seat automatically moves into proper position when back is adjusted • 10 weight-storage horns hold over 454 kg / 1000 lbs. of Olympic plates • Designed to meet EN957 and ASTM safety standards

	PRODUCT DIMENSIONS (L X W X H)						PRODUCT WEIGHT	
	CM	INCHES		KG	LBS			
MG-C895	167	180	173	71	66	68	155	342





MULTI-ADJUSTABLE BENCH LP

Seat automatically adjusts with the back pad for ease of use • Adjustable back pad with 8 positions from 0 to 75 degrees • Tapered wide back pad stabilizes users during heavy lifts • Molded guards protect high wear / scuff areas • Transport handle and integrated wheels simplify movement within facility • Low 17.8" floor-to-pad height minimizes lower back stress and prevents arching

	PRODUCT DIMENSIONS (L X W X H)						PRODUCT WEIGHT	
	CM			INCHES			KG	LBS
MG-A82	152	78	46	59.7	30.6	17.8	55	121.5



MULTI-ADJUSTABLE BENCH

Seat automatically adjusts with the back pad for ease of use • Adjustable back pad with 5 positions from 0 to 80 degrees • Wide back pad stabilizes users during heavy lifts • Molded guards protect high wear / scuff areas • Drop-away handle and integrated wheels simplify movement within facility

	PRODUCT DIMENSIONS (L X W X H)						PRODUCT WEIGHT	
	CM			INCHES			KG	LBS
MG-A85	135	58	51	53	23	20	43	95



FLAT BENCH

Single cross leg provides more freedom for users • Wide back pad stabilizes users during heavy lifts • Molded guards protect high wear / scuff areas • Integrated wheels simplify movement within facility

	PRODUCT DIMENSIONS (L X W X H)						PRODUCT WEIGHT	
	CM			INCHES			KG	LBS
MG-A59	142	58	46	56	23	18	25	55



MULTI-ADJUSTABLE BENCH W/DECLINE

Backrest adjusts into 7 positions — decline: -10 and 2.5 degrees; incline: 17.5, 32, 48, 64.5 and 87.5 degrees • Wide back pad stabilizes users during heavy lifts • Molded guards protect high wear / scuff areas • Leg pads provide added stability • Integrated wheels simplify movement within facility

	PRODUCT DIMENSIONS (L X W X H)						PRODUCT WEIGHT	
	CM			INCHES			KG	LBS
MG-A86	166	60.5	53.5	65.3	23.8	21	62	137



UTILITY BENCH

Oversized foot supports provide maximum stability • Molded guards protect high wear / scuff areas • Oversized rubber foot platforms provide added stability • Integrated wheels simplify movement within facility

	PRODUCT DIMENSIONS (L X W X H)						PRODUCT WEIGHT	
	CM		INCHES				KG	LBS
MG-A87	142	66	89	56	26	35	31	68



ADJUSTABLE DECLINE BENCH

9 adjustments from 10 to 30 degrees • Gas-assist for easy adjustment • Wide back pad stabilizes users during heavy lifts • Molded guards protect high wear / scuff areas • Integrated wheels for easy transport

	PRODUCT DIMENSIONS (L X W X H)						PRODUCT WEIGHT	
	CM		INCHES				KG	LBS
MG-A61	163	64	81	64	25	32	45	99



ADJUSTABLE AB BENCH

Adjustable leg pad accommodates all users • Molded guards protect high wear / scuff areas • Back support pivots into 6 different positions from 0 to 25 degrees • Elevated knee position reduces lower-back stress

	PRODUCT DIMENSIONS (L X W X H)						PRODUCT WEIGHT	
	CM		INCHES				KG	LBS
MG-A77	155	69	145	61	27	57	59	131



GLUTE HAM BENCH

Step-through design • Leg pads and oversized footplate can be adjusted while in exercise position • Gas-assisted leg pad offers easy vertical adjustment • Handles to perform reverse hyperextensions • Hooks to attach bands for reverse hyperextensions

	PRODUCT DIMENSIONS (L X W X H)						PRODUCT WEIGHT	
	CM		INCHES				KG	LBS
MG-A96	157	91	130	62	36	51	136	300



STANDING ARM CURL

Arm pad height adjusts to accommodate users of all sizes • Durable extruded guards protect frame and bar • Utilizing both sides of the machine increases functionality and saves space

MG-A71	PRODUCT DIMENSIONS (L X W X H)						PRODUCT WEIGHT	
	CM			INCHES			KG	LBS
	119	79	104	47	31	41	61	135



PREACHER CURL

Angled, ratcheting seat encourages proper body positioning • Durable extruded guards protect frame and bar

MG-A62	PRODUCT DIMENSIONS (L X W X H)						PRODUCT WEIGHT	
	CM			INCHES			KG	LBS
	119	76	99	47	30	39	57	125



VKR W/CHIN

Oversized round handles enhance comfort on dip • Angled back support, elbow pads and handles provide added stability and comfort • Multiple chin grips and rock-climbing grips add exercise variety

MG-A63C	PRODUCT DIMENSIONS (L X W X H)						PRODUCT WEIGHT	
	CM			INCHES			KG	LBS
	135	109	245	53	43	96	120	265



SQUAT RACK

Fixed-bottom stops provide added security • Molded urethane guards protect Olympic bars from damage and reduce noise • 5 racking positions and 8 weight-storage horns are standard • Bottom stops can also be used to hold bar for various exercises • Safety Distance from Floor 71.75 cm / 28.25"

	PRODUCT DIMENSIONS (L X W X H)						PRODUCT WEIGHT	
	CM		INCHES				KG	LBS
MG-A81	211.5	166.8	201	83.3	67.5	79.2	265	585



POWER STATION

Adjustable bar stop allows positioning from 30.5" to 48" • Fixed side frame is positioned at 20° for Olympic lifts • Eight racking positions accommodate users for any type of lift • Integrated pull-up bar for increased functionality • Eight standard weight horns hold multiple weight plate sizes

	PRODUCT DIMENSIONS (L X W X H)								PRODUCT WEIGHT	
	CM		INCHES				KG	LBS		
MG-A73	185.5	160.4	222.6	73	63.2	87.7	187.2	412.7		





BACK EXTENSION BENCH

Large thigh pads and skid-resistant foot platform for enhanced stability • Handles offer easy entry and exit • Molded guards protect high wear / scuff areas

	PRODUCT DIMENSIONS (L X W X H)						PRODUCT WEIGHT	
	CM			INCHES			KG	LBS
MG-A52	118.6	76.3	97.3	46.7	30	38.3	53	117



MI BACK TRAINER

Large thigh pads and skid-resistant foot platform for enhanced stability • Handles offer easy entry and exit • Hooks to attach bands for added resistance • 3 different pad adjustment angles (55, 40, 25 degrees) • Gas-assist for easy adjustment

	PRODUCT DIMENSIONS (L X W X H)						PRODUCT WEIGHT	
	CM			INCHES			KG	LBS
MD-FW52	135.5	73.1	100.1	53.4	28.8	39.4	58	128



BARBELL RACK

Upright design provides convenience for barbell accessories • Rack holds 10 barbells, 5 per side • Chromed pegs provide lasting commercial finish

	PRODUCT DIMENSIONS (L X W X H)						PRODUCT WEIGHT	
	CM			INCHES			KG	LBS
MG-A98	138.5	88.7	152.9	54.5	34.9	60.2	81	178.6



OLYMPIC WEIGHT TREE

9 chrome-plated storage horns for Olympic plates • Rubber bumpers on horns protect frame finish • Ergonomic design positions heavier plates further off the ground for easier removal and replacement

	PRODUCT DIMENSIONS (L X W X H)						PRODUCT WEIGHT	
	CM			INCHES			KG	LBS
MG-A94	87.1	57	107.9	34.3	22.5	42.5	28.8	63.5



WEIGHT TREE W/BAR HOLDERS

6 chromed storage horns, 2 of which accommodate 20-kg / 45-lb. plates • 2 vertical bar holders for Olympic or curl bar storage • Rubber bumpers on horns protect frame finish

	PRODUCT DIMENSIONS (L X W X H)						PRODUCT WEIGHT	
	CM			INCHES			KG	LBS
MG-A67B	51	52	112	20	21	44	23	50



ACCESSORY RACK

Facilitates placement of all accessories in one spot for convenience and a clutter-free facility • Top shelf holds additional accessories

	PRODUCT DIMENSIONS (L X W X H)						PRODUCT WEIGHT	
	CM			INCHES			KG	LBS
MG-A97	110.1	69.4	110.5	43.4	27.4	43.5	47.6	105



STEP-UP PLATFORM W/HANDLE

20 cm / 8" step-up height • Non-slip surface

	PRODUCT DIMENSIONS (L X W X H)						PRODUCT WEIGHT	
	CM			INCHES			KG	LBS
MG-SUP	95	48	122.5	37.5	19	48.25	34	75



SPOTTER PLATFORM

Wide-tapered rubber platform provides additional leverage for heavy lifting • Available as an option on the MG-A78 and MG-A678 Olympic Flat Benches • Standard on the Olympic Incline and Shoulder Press Benches

	PRODUCT DIMENSIONS (L X W X H)						PRODUCT WEIGHT	
	CM			INCHES			KG	LBS
MG-A0SP	66	84	29	26	33	12	28	61

5-PAIR PRO-STYLE DUMBBELL RACK



Storage space for 5 pairs of pro-style dumbbells up to 68 kg / 150 lbs. • 15-degree angled tray helps prevent wrist strain when removing and replacing dumbbells • Cradles hold dumbbells securely in place to prevent rolling pinch hazards • Options available: decal sheet (MG-AODS); connector plate (MG-AOCP)

	PRODUCT DIMENSIONS (L X W X H)						PRODUCT WEIGHT	
	CM		INCHES				KG	LBS
MG-A505	232.6	61.3	79.8	91.6	24.2	31.5	63	138.6

10-PAIR PRO-STYLE DUMBBELL RACK



Storage space for 10 pairs of pro-style dumbbells up to 68 kg / 150 lbs. • 15-degree angled trays help prevent wrist strain when removing and replacing dumbbells • Cradles hold dumbbells securely in place to prevent rolling pinch hazards • Options available: decal sheet (MG-AODS); connector plate (MG-AOCP)

	PRODUCT DIMENSIONS (L X W X H)						PRODUCT WEIGHT	
	CM		INCHES				KG	LBS
MG-A510	232.6	61.3	79.8	91.6	24.2	31.5	106	233.2

15-PAIR PRO-STYLE DUMBBELL RACK



Storage space for 15 pairs of pro-style dumbbells up to 68 kg / 150 lbs. • 15-degree angled trays help prevent wrist strain when removing and replacing dumbbells • Cradles hold dumbbells securely in place to prevent rolling pinch hazards • Options available: decal sheet (MG-AODS); connector plate (MG-AOCP)

	PRODUCT DIMENSIONS (L X W X H)						PRODUCT WEIGHT	
	CM		INCHES				KG	LBS
MG-A515	232.6	67.3	102.1	91.6	26.5	40.2	156	343.2

2-TIER FLAT-TRAY DUMBBELL RACK



231 cm / 91" rack holds hex head dumbbells weighing up to 52 kg / 115 lbs. • Also available: 185 cm / 73", 2-tier Flat-tray Dumbbell Rack (MG-A526) • Options available: kettlebell storage insert (MG-AO15T for top tray, MG-AO15B for bottom tray); rubber mat insert (MG-AORM6 for MG-A526 dumbbell rack, MG-AORM8 for MG-A528 dumbbell rack); decal sheet (MG-AODS); connector plate (MG-AOCP)

	PRODUCT DIMENSIONS (L X W X H)						PRODUCT WEIGHT	
	CM		INCHES				KG	LBS
MG-A528	232.2	62.5	79.4	91.5	24.6	31.3	127	279.4
MG-A526	186.2	62.5	79.4	73.3	24.6	31.3	108	237.6



3-TIER FLAT-TRAY DUMBBELL RACK

231 cm / 91" rack holds hex head dumbbells weighing up to 52 kg / 115 lbs. • Also available: 185 cm / 73", 3-tier Flat-tray Dumbbell Rack (MG-A536) • Options available: kettlebell storage insert (MG-AO15T for top tray, MG-AO15B for bottom tray); rubber mat insert (MG-AORM6 for MG-A536 dumbbell rack, MG-AORM8 for MG-A538 dumbbell rack); decal sheet (MG-AODS); connector plate (MG-AOCP)

	PRODUCT DIMENSIONS (L X W X H)						PRODUCT WEIGHT	
	CM		INCHES				KG	LBS
MG-A538	232.2	72.4	101.8	91.5	28.5	40	193	424.6
MG-A536	186.2	72.4	101.8	73.3	28.5	40	160	352



STUDIO PRO-STYLE DUMBBELL RACK

Storage space for 10 pairs of pro-style dumbbells from 2-20 kg / 5-50 lbs. • 15-degree angled trays help prevent wrist strain when removing and replacing dumbbells • Space-saving design minimizes footprint and uses less space than traditional 10-pair 2-tier rack • Cradles hold dumbbells securely in place to prevent rolling pinch hazards • Options available: decal sheet (MG-AODS); connector plate (MG-AOCP)

	PRODUCT DIMENSIONS (L X W X H)						PRODUCT WEIGHT	
	CM		INCHES				KG	LBS
MG-A541	186.2	67.3	102.1	73.3	26.5	40.2	123	270.6



STUDIO FLAT-TRAY DUMBBELL RACK

122 cm / 48" rack holds 2-20 kg / 5-50 lb. hex head dumbbells • Options available: kettlebell storage insert (MG-AO15T for top tray, MG-AO15B for bottom tray); rubber mat insert (MG-AORM4); decal sheet (MG-AODS); connector plate (MG-AOCP)

	PRODUCT DIMENSIONS (L X W X H)						PRODUCT WEIGHT	
	CM		INCHES				KG	LBS
MG-A544	123.2	72.4	101.8	48.5	28.5	39.4	118	259.6

GLUTE TRAINER /

SMART & STABLE

Help athletes tone muscle, build power, and improve hip and core stability with a smarter, more stable take on high-intensity glute training. Advanced biomechanics mimic bar hip thrusting without the difficulty and discomfort of free weights, and walk-through design makes it easy for anyone to get started. Refined ergonomics accommodate users of all sizes comfortably, while high maximum resistance and elastic band hooks challenge even elite athletes.

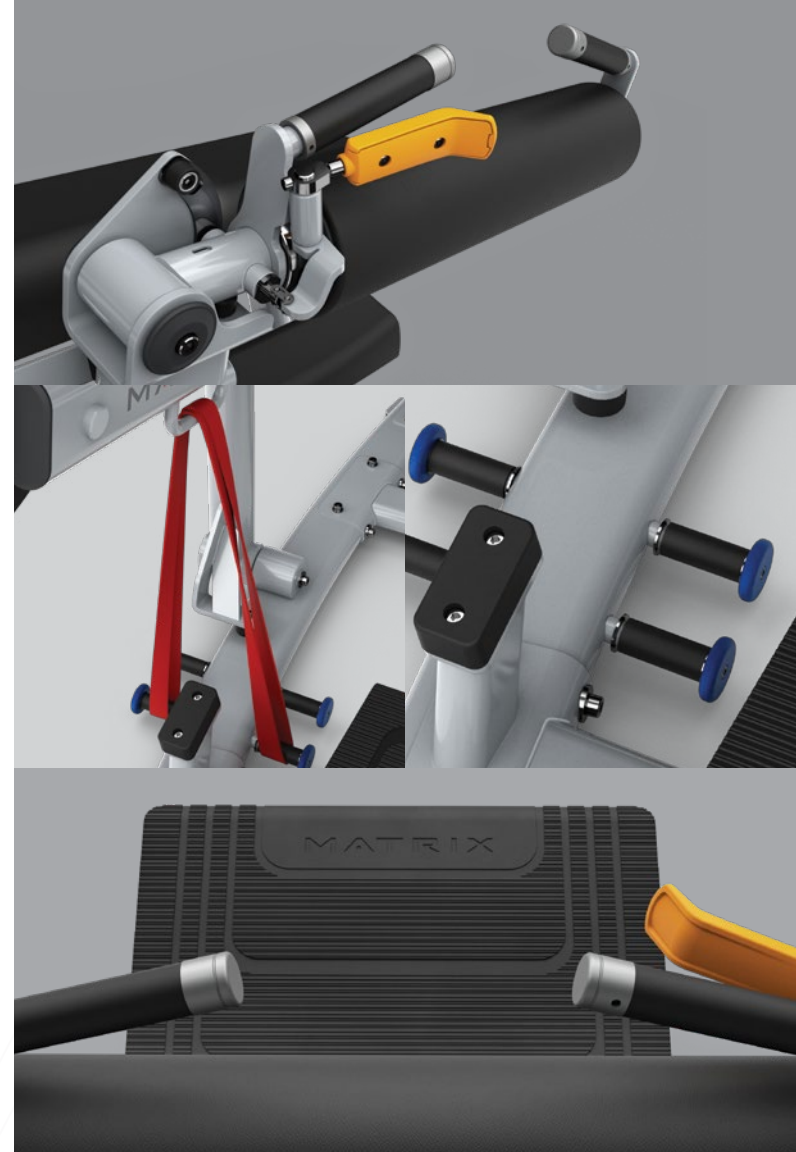





VERTICAL BENCH PRESS

Independent converging movement provides a natural path of motion • Back pad adjusts to alter range of motion and expand training options • Dual-grip pressing positions offer greater training variety • Ratcheting seat for easy adjustment • 4 integrated weight-storage horns

	PRODUCT DIMENSIONS (L X W X H)						PRODUCT WEIGHT	
	CM		INCHES				KG	LBS
MG-PL12	146.5	168.5	199.5	58.0	66.5	78.5	196	432



SUPINE BENCH PRESS

Independent converging movement provides a natural path of motion • Dual-grip pressing positions offer greater training variety • 2 integrated weight-storage horns

	PRODUCT DIMENSIONS (L X W X H)						PRODUCT WEIGHT	
	CM		INCHES				KG	LBS
MG-PL13	184.5	127.5	89.5	72.5	50	35	99	218.5



INCLINE BENCH PRESS

Independent converging movement provides a natural path of motion • Back pad adjusts to alter range of motion and expand training options • Dual-grip pressing positions offer greater training variety • Ratcheting seat for easy adjustment • 4 integrated weight-storage horns

	PRODUCT DIMENSIONS (L X W X H)						PRODUCT WEIGHT	
	CM		INCHES				KG	LBS
MG-PL14	208.2	143.2	129.6	82	56.5	51	147.5	325



VERTICAL DECLINE BENCH PRESS

Independent converging movement provides a natural path of motion • Back pad adjusts to alter range of motion and expand training options • Dual-grip pressing positions offer greater training variety • Ratcheting seat for easy adjustment • 4 integrated weight-storage horns

	PRODUCT DIMENSIONS (L X W X H)						PRODUCT WEIGHT	
	CM		INCHES				KG	LBS
MG-PL15	148	168.5	195	58.5	66.5	77	195.5	431



SHOULDER PRESS

Independent converging movement provides a natural path of motion • Slightly reclined position reduces lower back strain • Dual-grip pressing positions offer greater training variety • Ratcheting seat for easy adjustment • 4 integrated weight-storage horns

	PRODUCT DIMENSIONS (L X W X H)						PRODUCT WEIGHT	
	CM		INCHES				KG	LBS
MG-PL23	161.3	160	118.1	63.5	63	46.5	118	260



LAT PULLDOWN

Diverging independent arms provide a natural path of motion • Easy-to-use thigh-pad adjustment for proper support • Angled seat cues optimal user position • 2 integrated weight-storage horns

	PRODUCT DIMENSIONS (L X W X H)						PRODUCT WEIGHT	
	CM		INCHES				KG	LBS
MG-PL33	182.9	123.2	190.5	72	48.5	75	128	282



SEATED ROW

Diverging independent arms provide a natural path of motion • Dual-grip positions offer greater training variety • Two different foot positions accommodate a greater variety of user heights • Ratcheting seat for easy adjustment • Integrated weight-storage horn

	PRODUCT DIMENSIONS (L X W X H)						PRODUCT WEIGHT	
	CM		INCHES				KG	LBS
MG-PL34	152.4	139.7	106.7	60	55	42	118	260



AB CRUNCH BENCH

Dual-supported pivot for added strength and performance • Lower step-through height for easy entry and exit • Dual-action pivot for natural biomechanics • Angled handles enhance shoulder comfort and feel • Center tube supports heavier individuals • Weight horn accommodates 12-kg / 25-lb. plates for advanced users

	PRODUCT DIMENSIONS (L X W X H)						PRODUCT WEIGHT	
	CM		INCHES				KG	LBS
MG-PL50	162.6	88.9	100.3	64	35	39.5	60	132.5



SMITH MACHINE

Counterbalanced 11.3-kg / 25-lb. bar takeoff for low starting resistance • Features a 90-degree path of motion adapts to all exercises • Linear bearings provide a smooth motion • Non-removable safety stops add training security • 8 integrated weight-storage horns hold multiple weight-plate sizes

	PRODUCT DIMENSIONS (L X W X H)				PRODUCT WEIGHT			
	CM	INCHES	KG	LBS				
MG-PL62	110.5	231.1	245.1	43.5	91	96.5	270	569



45° LEG PRESS

Easy-to-use and see racking mechanism • Adjustable bottom stops provide long or short ranges of motion for all user heights • Adjustable angle back pad enhances comfort, optimizes hip angles and accommodates a greater range of users • Assistance handle on platform for easier entry and exit • Linear bearings for smooth feel and function • 4 integrated weight-storage horns hold multiple weight-plate sizes

	PRODUCT DIMENSIONS (L X W X H)						PRODUCT WEIGHT	
	CM		INCHES				KG	LBS
MG-PL70	229	171	158	90	67.5	62.3	274	604



GLUTE TRAINER

Comfortable user positioning and efficient machine layout mimic bar hip thrusting without the hassle of unwieldy free weights • Walk-through design with swiveling hip pad provides easy entry and exit • Maximum resistance of 227 kg / 500 lbs. • Integrated dual-sided band hooks provide elastic resistance for explosiveness training and movement variety • Floating hip pad adjusts to fit users of all sizes and comfortable feel • Large, angled foot platform with non-slip surface offers excellent stability to better engage glutes • Oversized shoulder pad provides comfortable torso support

	PRODUCT DIMENSIONS (L X W X H)						PRODUCT WEIGHT	
	CM		INCHES				KG	LBS
MG-PL78	168	133	109	66.5	52.5	43	154	340



HACK SQUAT

Large footplate and back pad accommodate users of all sizes • Spring-loaded take off handles for ease of use and engagement • Adjustable bottom stops provide long or short ranges of motion for all user heights • 4 integrated weight-storage horns

	PRODUCT DIMENSIONS (L X W X H)						PRODUCT WEIGHT	
	CM		INCHES				KG	LBS
MG-PL71	228.2	150	144.6	90	59	57	270	595



SQUAT / LUNGE

Independent lifting arms for balanced exercise and exercise variation • Multiple hand-grip positions offer greater training variety • 3 integrated weight-storage horns keep weight plates in close proximity • 4 user weight horns provide maximal loading for strong users

	PRODUCT DIMENSIONS (L X W X H)						PRODUCT WEIGHT	
	CM		INCHES				KG	LBS
MG-PL79	148.6	170.2	86.4	58.5	67	34	120	264.5



STANDING CALF

Adjustable height shoulder pads accommodate users of all sizes • Angled footplate provides superior grip and improves calf recruitment • Angled support handles enhance comfort

	PRODUCT DIMENSIONS (L X W X H)						PRODUCT WEIGHT	
	CM			INCHES			KG	LBS
MG-PL76	138	89	184.5	54.5	35	73	124	273.5



REVERSE BACK EXTENSION

Adjustable starting point to select desired range of motion • Leg pad can be locked in forward position to use without resistance • Dual hand grips provide added variety and comfort • 2 weight-storage horns

	PRODUCT DIMENSIONS (L X W X H)						PRODUCT WEIGHT	
	CM			INCHES			KG	LBS
MG-405	150	109	145	59	43	57	134	295



SEATED CALF

Seat moves with input arm to maintain alignment • Curved and angled foot pad improves comfort and calf recruitment • Quick-release bar catch simplifies operation • Knee pads adjust for tibia length and range of motion

	PRODUCT DIMENSIONS (L X W X H)						PRODUCT WEIGHT	
	CM			INCHES			KG	LBS
MG-PL77	141	80	96.5	55.5	31.5	38	65	143.5



DOUBLE MEGA RACK CONFIGURATION

It doesn't get any bigger than this. Matrix Double MEGA Racks take your training to the max. A combination of two racks and custom connecting elements, the Double MEGA Rack allows you to tailor your equipment to your facility. This flexibility enables you to define your own priorities and get the most out of your investment each and every training day. Plus, the Matrix 7-gauge steel uprights and heavy-duty frames mean the Double MEGA Rack can simultaneously handle your toughest athletes and your most rigorous workouts. Maximize your space and your athletes at the same time with the Double MEGA Rack.

** Shown with optional accessories.*







MEGA POWER RACK

Fully enclosed style offers ideal spotting abilities • Shown with adjustable safety bars, dual-grip chin bar, bar storage, band storage and weight storage • J-hooks made of high-density polyethylene (HDPE) to protect Olympic bars from scratches • Visual height indicator and colored locking pin make bar-level changes quick and easy • 3 retractable lower-band pegs on each side (6 total)

	PRODUCT DIMENSIONS (L X W X H)						PRODUCT WEIGHT	
	CM		INCHES				KG	LBS
MG-MR47	206	207	246.5	81	81.5	97	347	765



MEGA HALF RACK

Open-front design gives users freedom of movement • Shown with adjustable safety bars, dual-grip chin bar, bar storage, band storage and weight storage • J-hooks made of high-density polyethylene (HDPE) to protect Olympic bars from scratches • Visual height indicator and colored locking pin make bar-level changes quick and easy • 3 retractable lower-band pegs on each side (6 total)

	PRODUCT DIMENSIONS (L X W X H)						PRODUCT WEIGHT	
	CM		INCHES				KG	LBS
MG-MR690	170.5	207	246.5	67	81.5	97	259	570





MEGA PLATFORM W/ HARDWOOD INSERT

Durable rubber training surface to absorb impact, dampen noise and protect flooring during Olympic lifts • Hardwood center insert provides optimum foot grip and stability during explosive Olympic lifts • MA4794P for use with the MR47, A47, MR694, A94 • MA90191P for use with MR690, A690, MR691, A691 • Available training area length options: 131 cm / 4' (MA4794P-4, MA90191P-4) and 191 cm / 6' (MA4794P, MA90191P)

	PRODUCT DIMENSIONS (L X W X H)						PRODUCT WEIGHT	
	CM			INCHES			KG	LBS
MA4794P-4	305	254	7	120	100	2.6	195.5	431
MA90191P-4	270	254	7	106	100	2.6	186.5	411
MA4794P	363	254	7	143	100	2.6	259.5	572
MA90191P	328	254	7	129	100	2.6	250.5	552



MEGA SOLID RUBBER SURFACE PLATFORM

Durable rubber training surface to absorb impact, dampen noise and protect flooring during Olympic lifts • Options available: MEGA Solid Rubber Surface Platform • MARP4794 for use with MR47, A47, MR694, A694 • MARP9091 for use with MR690, A690, MR691, A691 • Available training area length options: 131 cm / 4' (MARP4794-4, MARP9091-4) and 191 cm / 6' (MARP4794, MARP9091)

	PRODUCT DIMENSIONS (L X W X H)						PRODUCT WEIGHT	
	CM			INCHES			KG	LBS
MARP4794-4	305	254	7	120	100	2.6	215.5	475
MARP9091-4	270	254	7	106	100	2.6	203	448
MARP4794	366	254	7	144	100	2.6	292.5	645
MARP9091	330	254	7	130	100	2.6	280	617

MAGNUM VRS PLATFORM

Reduce sound, vibration and bounce while protecting your equipment with our Vibration Reduction System.

Create an unmatched strength training environment with platforms featuring our exclusive Vibration Reduction System. Our impact-absorption platforms reduce sound and bounce caused by dropping barbells during Olympic lifts, protecting floors, bars, weights, and plates from hard use. The multi-layer design minimizes vibrations transferred through floors, essential for above-ground training facilities. VRS Platform kits are available in a variety of styles and sizes, so it's easy to upgrade existing Matrix platforms or create a rugged new training experience featuring our Vibration Reduction System.



	PRODUCT DIMENSIONS (L X W X H)					PRODUCT WEIGHT		
	CM			INCHES		KG	LBS	
MA4794P-VRS	366	254	7	144	100	2.6	227	500.5
MA4794P-VRS-4	305	254	7	120	100	2.6	174	383.5
MA9091P-VRS	330	254	7	130	100	2.6	218	480.5
MA9091P-VRS-4	270	254	7	106	100	2.6	165	363.5
PS86-VRS	191	254	7	75	100	2.6	184	406
PS84-VRS	131	254	7	51.5	100	2.6	131	289
VRS-KIT	181.5	68	11.5	71.5	26.8	4.5	71	156
VRS-KIT-4	121	68	11.5	48	26.8	4.5	47.5	104



STAND-ALONE RUBBER PLATFORM W/HARDWOOD INSERT

Durable rubber training surface to absorb impact, dampen noise and protect flooring during explosive Olympic lifts • Hardwood center insert provides optimum foot grip and stability during explosive Olympic lifts • Available training area length options: 131 cm / 4' (PS84) and 191 cm / 6' (PS86)

	PRODUCT DIMENSIONS (L X W X H)						PRODUCT WEIGHT	
	CM			INCHES			KG	LBS
PS84	131	254	7	51.5	100	2.6	153	337
PS86	191	253	7	75	100	2.6	216.5	477



STAND-ALONE SOLID RUBBER PLATFORM

Durable rubber training surface to absorb impact, dampen noise and protect flooring during Olympic lifts • Available training area length options: 131 cm / 4' (RP84) and 191 cm / 6' (RP86)

	PRODUCT DIMENSIONS (L X W X H)						PRODUCT WEIGHT	
	CM			INCHES			KG	LBS
RP84	131	254	7	51.5	100	2.6	156	344
RP86	191	253	7	75	100	2.6	233	514

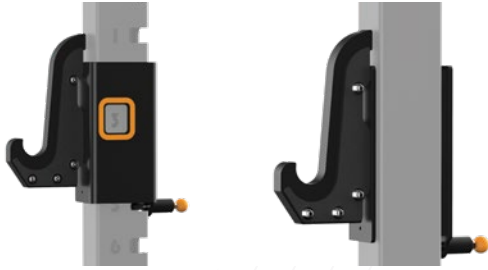

REVERSE J-HOOKS

Made of high-density polyethylene (HDPE) to protect bar knurling • For use on the outside of the MR47 Mega Power Rack • Available in Ridge Black only

	PRODUCT DIMENSIONS (L X W X H)						PRODUCT WEIGHT	
	CM			INCHES			KG	LBS
OPT1R	36	13	25	14	5	10	14	30

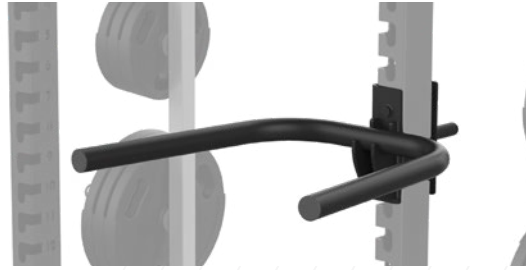

DIP BARS

Attaches to rack uprights for body-weight dips • For use on the MR690 Mega Half Rack • Also available: Reverse Dip Bars (OPT3R) for use on the MR47 Mega Power Rack • Available in Ridge Black only

	PRODUCT DIMENSIONS (L X W X H)						PRODUCT WEIGHT	
	CM			INCHES			KG	LBS
OPT3	86	69	26	34	27	10	16	35



SQUAT HANDLES

Squat handles can be set at any height on all rack uprights • Available in Ridge Black only

	PRODUCT DIMENSIONS (L X W X H)						PRODUCT WEIGHT	
	CM			INCHES			KG	LBS
OPT6	23	23	13	9	9	5	8	16



REVERSE STEP-UP PLATFORM

Adjustable height platform provides additional body-weight exercises • For use on the outside of the MR47 Mega Power Rack • Available in Ridge Black only

	PRODUCT DIMENSIONS (L X W X H)						PRODUCT WEIGHT	
	CM			INCHES			KG	LBS
OPT7R	82	61	39	32	24	15	22	47

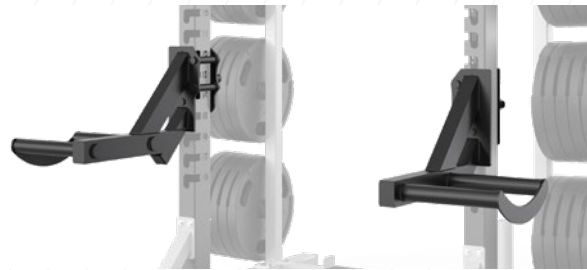

TECHNIQUE SCOOPS

Large cradles accept bumper plates to assist with Olympic lifts and customized takeoff heights • For use on the MR690 Mega Half Rack • Also available: Reverse Technique Scoops (OPT8R) for use on the outside of the MR47 Mega Power Rack • Available in Ridge Black only

	PRODUCT DIMENSIONS (L X W X H)						PRODUCT WEIGHT	
	CM			INCHES			KG	LBS
OPT8	66	41	38	26	16	15	39	86



PLATFORM RAMP

Ramp allows for gradual incline to rack platforms • Replaces standard platform framework • Available in Ridge Black only

	PRODUCT DIMENSIONS (L X W X H)						PRODUCT WEIGHT	
	CM			INCHES			KG	LBS
OPT11	14.5	107	6.5	5.7	42	2.5	6	13.2



MEGA LAND MINE ATTACHMENT

Attaches to any rack for rotational training (bar not included) • Available in Ridge Black only

	PRODUCT DIMENSIONS (L X W X H)						PRODUCT WEIGHT	
	CM		INCHES				KG	LBS
MOPT13	67	21	19.5	26.3	8.3	7.7	9.5	21



CORE HANDLE

Used with an Olympic bar and Land Mine Attachment for added training variety • Available in Ridge Black only

	PRODUCT DIMENSIONS (L X W X H)						PRODUCT WEIGHT	
	CM		INCHES				KG	LBS
OPT16	48	79	5	19	31	2	5	10



JAMMIN ARMS

Angled pressing arms can be placed at 13 different heights for added training variety • For use on the MR690 Mega Half Rack • Also available: Reverse Jammin Arms (OPT17R) for use on the outside of the MR47 Mega Power Rack

	PRODUCT DIMENSIONS (L X W X H)						PRODUCT WEIGHT	
	CM		INCHES				KG	LBS
OPT17	94	53	94	37	21	37	49	108



JAMMIN ARMS W/ BAND ATTACHMENT

Angled pressing arms with band attachments for added training variety with speed and resistance • For use on the MR690 Mega Half Rack • Also available: Reverse Jammin Arms w/ Band Attachment • (OPT17RB) for use on the MR47 Mega Power Rack

	PRODUCT DIMENSIONS (L X W X H)						PRODUCT WEIGHT	
	CM		INCHES				KG	LBS
OPT17B	107	56	97	42	22	38	52	114



SAFETY ARM STORAGE

Bolt-on storage for safety arms provides easy access to arms when not in use • For use on the MR690 Mega Half Rack • Available in Ridge Black only

	PRODUCT DIMENSIONS (L X W X H)						PRODUCT WEIGHT	
	CM		INCHES				KG	LBS
OPT22	23	21	9	9	8	3.5	2	4



FAT BAR J-HOOKS

Made of high-density polyethylene (HDPE) to protect bar knurling • Oversized hooks accommodate large-diameter Olympic bars • Also available: Reverse Fat Bar J-hooks (OPT26R) for use on the outside of the MR47 Mega Power Rack • Available in Ridge Black only

	PRODUCT DIMENSIONS (L X W X H)						PRODUCT WEIGHT	
	CM		INCHES				KG	LBS
OPT26	47	18	34	19	4	13	16	35



MEGA RACK DOCKING KIT W/ NO PLATFORM

Connects MG-A695 Flat-to-incline Bench w/ Horizontal Adjustment directly to racks without a platform • Available in Ridge Black only

	PRODUCT DIMENSIONS (L X W X H)						PRODUCT WEIGHT	
	CM			INCHES			KG	LBS
MOPT29	26	3	14	10	1	5.5	3	5



MEGA RACK DOCKING KIT W/ PLATFORM

Connects MG-A695 Flat-to-incline Bench w/ Horizontal Adjustment directly to racks when using a platform • available in Ridge Black only

	PRODUCT DIMENSIONS (L X W X H)						PRODUCT WEIGHT	
	CM			INCHES			KG	LBS
MOPT29P	25	9	7	9.9	3.5	2.7	1.1	2.4



MEGA RACK BATTLE ROPE ATTACHMENT

For rope training as an anchor point on any rack • Available in Chrome finish only

	PRODUCT DIMENSIONS (L X W X H)						PRODUCT WEIGHT	
	CM			INCHES			KG	LBS
MOPT31	18	23	17	7	9	7	4	7

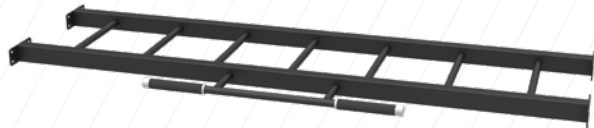

STRAIGHT LADDER

Horizontal ladder connecting power racks together for bodyweight training • For use on the MR47 Mega Power Rack • Also available: Straight Ladder Connecting Bracket in both 244 cm / 8' (OPT32-8) and 297 cm / 9'9" (OPT32-10) lengths • Available in Matte Black only

	PRODUCT DIMENSIONS (L X W X H)						PRODUCT WEIGHT	
	CM			INCHES			KG	LBS
OPT32-8	243.9	81.2	7.7	96	32	3	42.5	93.6
OPT32-10	297.2	81.2	7.7	117	32	3	51.5	113.2



PYRAMID LADDER

Elevated ladder connecting power racks together for bodyweight training • For use on the MR47 Mega Power Rack • Also available: Pyramid Ladder Connecting Bracket in 244 cm / 8' (OPT33-8) and 297 cm / 9'9" (OPT33-10) lengths • Available in Matte Black only

	PRODUCT DIMENSIONS (L X W X H)						PRODUCT WEIGHT	
	CM			INCHES			KG	LBS
OPT33-8	243.9	68.6	51.5	96	27	20.3	44.5	98
OPT33-10	297.2	68.6	53.1	117	27	20.9	53.3	117.2



MEGA STRAIGHT CHIN BAR

Pull-up bar connects power racks together for added bodyweight training • Available in 183 cm / 6' (MOPT35-6), 244 cm / 8' • (MOPT35-8) and 297 cm / 9'9" (MOPT35-10) lengths

	PRODUCT DIMENSIONS (L X W X H)						PRODUCT WEIGHT	
	CM			INCHES			KG	LBS
MOPT35-6	182.9	30.4	7.7	72	12	3	16.8	37
MOPT35-8	243.9	30.4	7.7	96	12	3	20.3	44.6
MOPT35-10	297.2	30.4	7.7	117	12	3	32.5	71.5



MEGA DUAL-SIDED FAT/STRAIGHT CHIN BAR

Multiple grip pull-up bar connects power racks together for added bodyweight training • Available in 183 cm / 6' (MOPT36-6)

	PRODUCT DIMENSIONS (L X W X H)						PRODUCT WEIGHT	
	CM			INCHES			KG	LBS
MOPT36-6	182.9	52.4	9.2	72	20.6	3.6	23.8	52.3



MEGA SIDE-MOUNTED PULL-UP BAR

Mounts upward or downward for bodyweight exercises or additional suspension-device exercises • For use on the MR47 Mega Power Rack • Available in Ridge Black only

	PRODUCT DIMENSIONS (L X W X H)						PRODUCT WEIGHT	
	CM			INCHES			KG	LBS
MOPT43	131	28	17	51.6	11	6.7	9	20



MEGA DUAL OLYMPIC BAR STORAGE

Vertical Olympic bar storage

	PRODUCT DIMENSIONS (L X W X H)						PRODUCT WEIGHT	
	CM			INCHES			KG	LBS
MOPT41	18	110	33	7	43	13	21.8	48

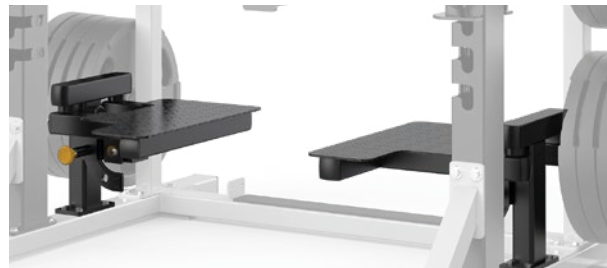

BOLT-ON SPOTTER STANDS

Two bolt-on spotter stands • Attaches to any rack • Available in Ridge Black only

	PRODUCT DIMENSIONS (L X W X H)						PRODUCT WEIGHT	
	CM			INCHES			KG	LBS
OPT45	38	81.5	29.5	15	32	11.5	31	68



MEGA ROTATING CHIN HANDLES

Handles rotate into multiple positions for added exercise variety • For use on the MR47 Mega Power Rack • Available in Ridge Black only

	PRODUCT DIMENSIONS (L X W X H)						PRODUCT WEIGHT	
	CM			INCHES			KG	LBS
MOPT42	16.1	109.2	46.4	6.4	43	18.3	15	33



BOLT-ON FRONT BAND PEG

Two bolt-on upper band pegs for added training variety • For use on the MR47 Mega Power Rack • Available in Ridge Black only

	PRODUCT DIMENSIONS (L X W X H)						PRODUCT WEIGHT	
	CM			INCHES			KG	LBS
OPT46	28	16	27	11	6.25	10.5	4	9



HORIZONTAL PLATE RACK

Can hold a maximum of 314 kg / 693 lbs. in various weight plate configurations • Includes 1 horn to hold collars, and 1 Olympic bar storage horn • Integrated wheels for easy transport • Available in Ridge Black only

	PRODUCT DIMENSIONS (L X W X H)						PRODUCT WEIGHT	
	CM		INCHES				KG	LBS
MG-A301	160	38.1	43.2	63	15	17	25	55



ATTACHMENT STORAGE RACK

Stores resistance chains and bands; also stores options for your Power Racks, such as dip bars, technique scoops, step-up platforms, etc. • Accessories not included • Available in Ridge Black only

	PRODUCT DIMENSIONS (L X W X H)						PRODUCT WEIGHT	
	CM		INCHES				KG	LBS
MG-A303	122	114	178	48	45	70	73	160



FLAT-TO-INCLINE BENCH W/HORIZONTAL ADJUSTMENT

Locking rods for attachment to power racks • Lever allows user to adjust horizontal length of bench while seated • Seat automatically adjusts to proper angle as the backrest is adjusted • Drop-away handle and wheels provide easy movement • *Optional docking kit required to secure bench to racks

	PRODUCT DIMENSIONS (L X W X H)						PRODUCT WEIGHT	
	CM		INCHES				KG	LBS
MG-A695	137	76	51	54	30	20	64	140

MAGNUM STANDARD FRAME AND UPHOLSTERY COLORS

Iced Silver frames

Obsidian Black – Upholstery



Clay Red – Upholstery

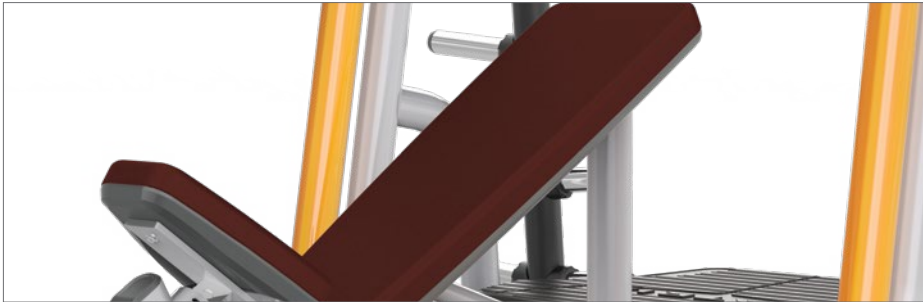

Slate Blue – Upholstery



Matte Black frames

Obsidian Black – Upholstery



Clay Red – Upholstery

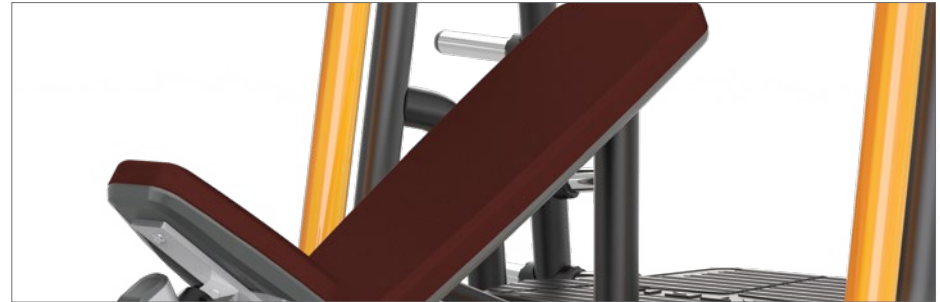

Slate Blue – Upholstery



NOTE: All specifications are subject to change without notice. Actual products may differ from those pictured in this catalog. Actual product colors may vary from what is shown here.



VARSITY SERIES /

DESIGNED FOR SUPERIOR VALUE AND TRAINING VARIETY



VARSITY SERIES /

The Varsity Series is the ideal choice for heavy-use facilities looking for a combination of performance and value. Smart design helps you make efficient use of your space and your budget, like our versatile functional trainers and plate-loaded equipment that provide conveniently contained personal training areas. If you're looking to accommodate a steady stream of users in a limited space, look no further than the Varsity Series.

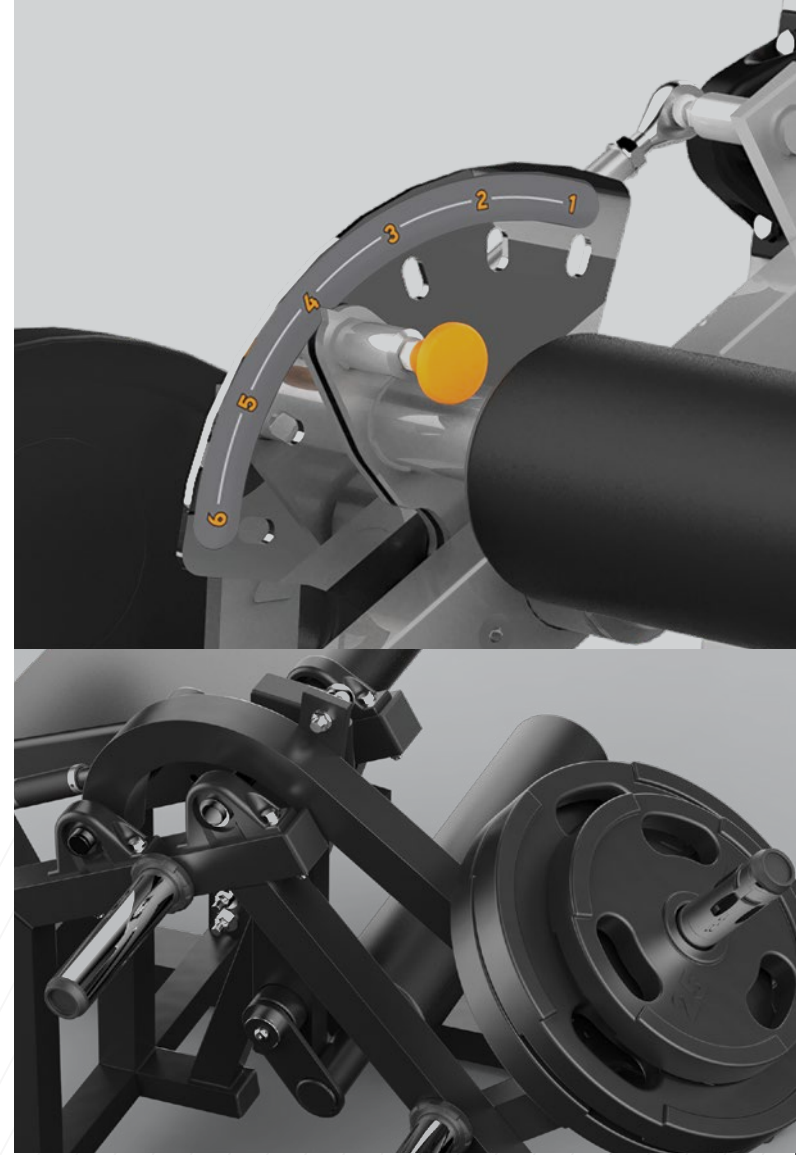

Durable Construction Built to withstand the rigorous strength training of professional sports teams.

Color-coded Adjustment Points Conveniently located and clearly marked for easy use. **Value** Designed to handle a steady stream of users for years to come.





ANGLED SMITH MACHINE

Olympic bar is counterbalanced to 11.8 kg / 26 lbs. • Olympic bar is mounted on linear bearings and shaft at a 7-degree angle • Open-ended frame design provides easy access • Flip in and out adjustable stops • 12 integrated weight-storage horns

	PRODUCT DIMENSIONS (L X W X H)						PRODUCT WEIGHT	
	CM		INCHES				KG	LBS
VY-M49	107	218	211	42	86	83	186	410



PERFECT SQUAT

Large, angled, heavy-duty footplate adds stability • Adjustable starting position allows user to set pad height for squats or standing calf raises • Shoulder pads maintain parallel position to floor throughout full range of motion • 2 integrated weight-storage horns • Ideal for squats, calf work and reverse lunges

	PRODUCT DIMENSIONS (L X W X H)						PRODUCT WEIGHT	
	CM		INCHES				KG	LBS
VY-400	157	84	168	62	33	66	147	325



LEG EXTENSION

Self-adjusting tibia pad enhances comfort • Back pad is adjustable from the seated position for proper alignment • 2 integrated weight-storage horns

	PRODUCT DIMENSIONS (L X W X H)						PRODUCT WEIGHT	
	CM			INCHES			KG	LBS
VY-401	102	157	117	40	62	46	91	200



PRONE LEG CURL

Divergent angle of lower-leg pad eliminates lower-back stress • Neutral position handgrips enhance comfort and stability

	PRODUCT DIMENSIONS (L X W X H)						PRODUCT WEIGHT	
	CM			INCHES			KG	LBS
VY-402	173	91	72	68	36	30	91	200



BICEPS CURL

Side arm pads encourage proper user positioning • 1 integrated weight-storage horn • Counterbalanced exercise arm offers optimal resistance

	PRODUCT DIMENSIONS (L X W X H)						PRODUCT WEIGHT	
	CM		INCHES				KG	LBS
VY-431	97	107	112	38	42	44	68	150



TRICEPS EXTENSION

Adjustable knee pads help stabilize user during exercise • Side arm pads encourage proper positioning • 1 integrated weight-storage horn • Counterbalanced exercise arm offers optimal resistance

	PRODUCT DIMENSIONS (L X W X H)						PRODUCT WEIGHT	
	CM		INCHES				KG	LBS
VY-432	97	107	140	38	42	55	68	150

VARSITY STANDARD FRAME AND UPHOLSTERY COLORS

Iced Silver frames

Obsidian Black – Upholstery

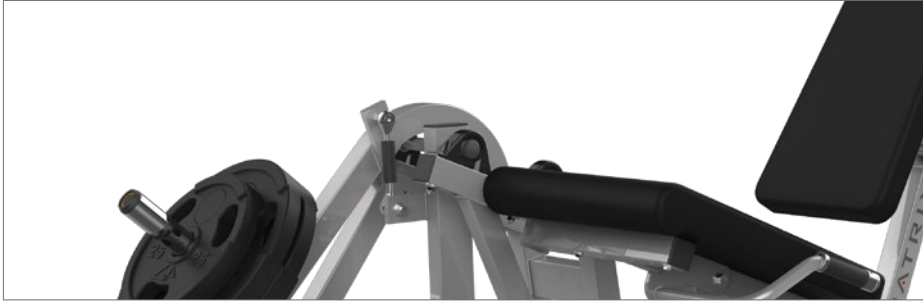

Clay Red – Upholstery

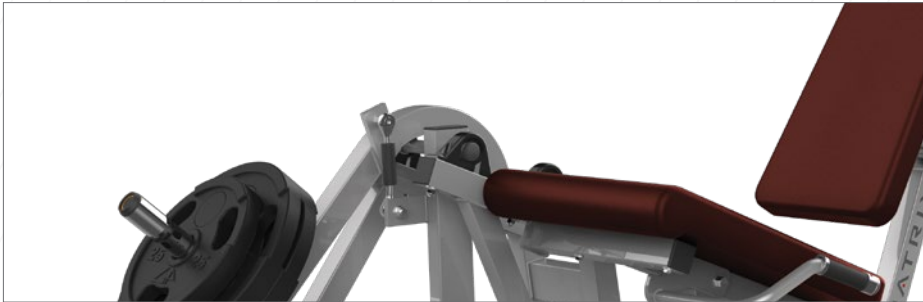

Slate Blue – Upholstery

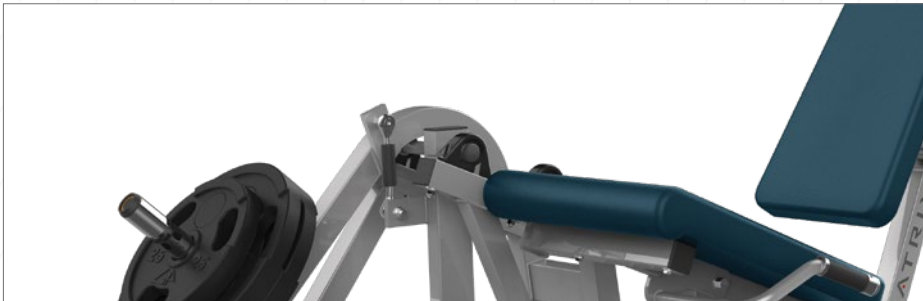

Matte Black frames

Obsidian Black – Upholstery



Clay Red – Upholstery



Slate Blue – Upholstery



NOTE: All specifications are subject to change without notice. Actual products may differ from those pictured in this catalog. Actual product colors may vary from what is shown here.

G1 SERIES /

DIVERSITY AND DURABILITY TO GET THE JOB DONE



G1 SERIES /

Ideal for cost-conscious fitness facilities, the G1 Series provides the value you need to outfit your space with the variety your members are seeking. The 3-stack multi-gym allows three users to simultaneously exercise key muscles while making efficient use of your space and your budget. The classic styling of our benches and racks are approachable and easily accessible for experienced and aspiring fitness enthusiasts alike, and every piece that hits your floor will stand up to heavy use, day in and day out for years.



MATRIX

Durable Construction Built to withstand the rigorous strength training of professional sports teams.

Ergonomic Design Designed to fit the body for comfortable, natural use. **Weight-storage Horns**

Conveniently positioned and designed to accommodate a variety of plate sizes. **Easy Access** Designed for quick on/off, ideal for busy training environments.

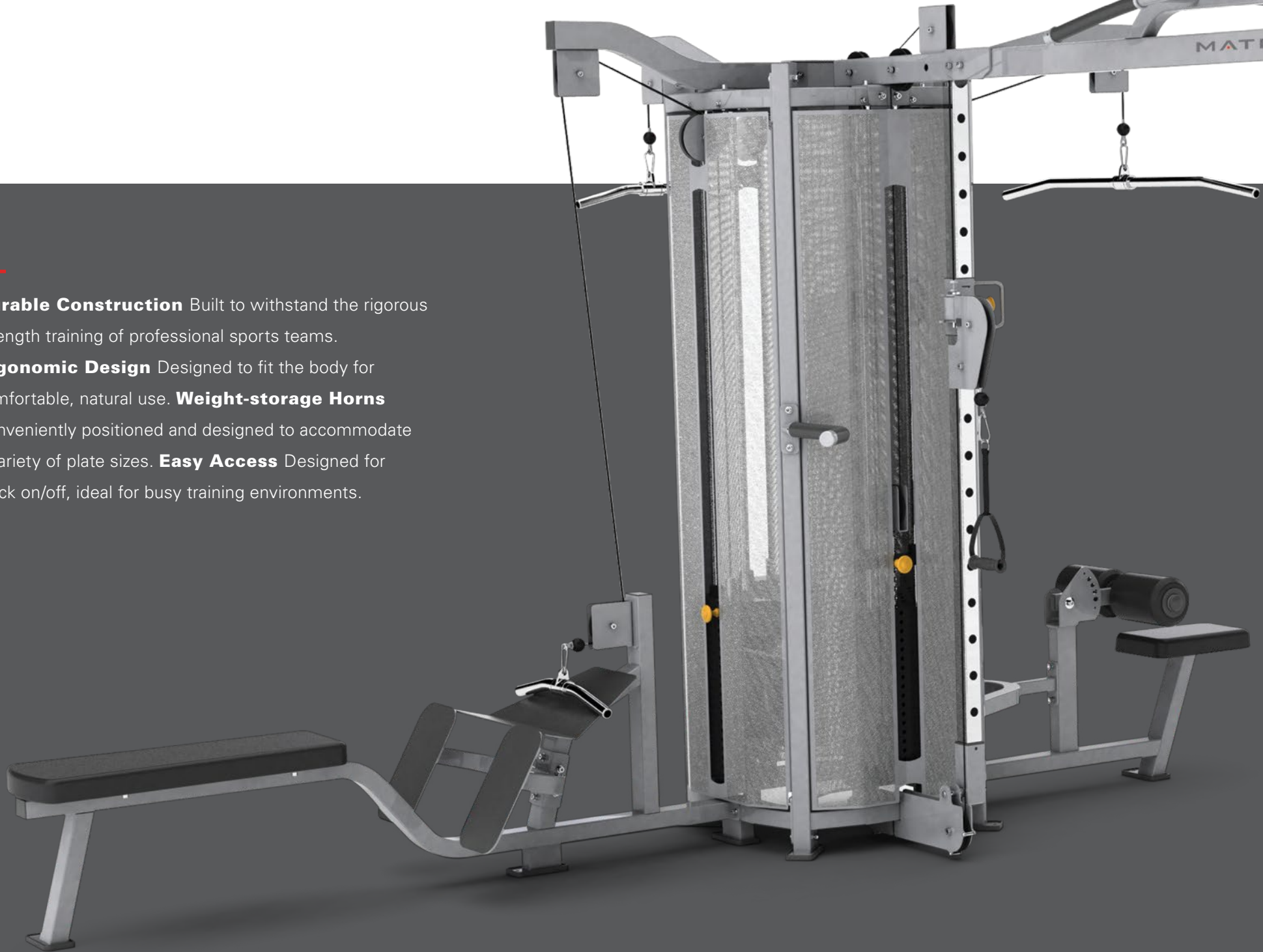



ADJUSTABLE CABLE CROSSOVER

Adjustable pulley provides 17 positions • Each weight stack provides a 1:2 resistance ratio • Integrated pull-up bar provides both lat bar and neutral grips • Front weight-stack shields meet EN requirements

	PRODUCT DIMENSIONS (L X W X H)						PRODUCT WEIGHT		WEIGHT STACK	
	CM	INCHES					KG	LBS	KG	LBS
G1-MS20	377	110	230	148	43	91	395	870	2 X 91	2 X 200



3-STACK MULTI-GYM

Three weight stacks allow multiple users to exercise simultaneously • Stations include: multiple position chest / shoulder press, lat pull-down / low row, leg extension / prone leg curl

	PRODUCT DIMENSIONS (L X W X H)						PRODUCT WEIGHT		WEIGHT STACK	
	CM			INCHES			KG	LBS	KG	LBS
G1-MG30	282	323	218	111	127	86	592	1305	3 X 91	3 X 200



4-STACK MULTI-STATION

Four weight stacks allow multiple users to exercise simultaneously • Weight stack shields meet EN requirements • Stations include lat pull-down, low row and triceps pull-down • Conveniently located adjustment points are clearly marked for ease of use • 8-stack multi-station includes additional lat pull-down, low row and triceps pull-down plus connecting tube for a complete cable crossover

	PRODUCT DIMENSIONS (L X W X H)						PRODUCT WEIGHT		WEIGHT STACK	
	CM			INCHES			KG	LBS	KG	LBS
G1-MS40	387	180	230	152	71	91	645	1420	4 X 91	4 X 200



5-STACK MULTI-STATION

Includes all of the features listed with the 4-stack multi-station • Additional adjustable cable column and connecting tube for a complete cable crossover

	PRODUCT DIMENSIONS (L X W X H)						PRODUCT WEIGHT		WEIGHT STACK	
	CM			INCHES			KG	LBS	KG	LBS
G1-MS50	482	386	230	190	152	91	857	1889	5 X 91	5 X 200



8-STACK MULTI-STATION

Includes all of the features listed with the 4-stack multi-station • 8-stack multi-station includes additional lat pull-down, low row and triceps pull-down plus connecting tube for a complete cable crossover

	PRODUCT DIMENSIONS (L X W X H)						PRODUCT WEIGHT		WEIGHT STACK	
	CM			INCHES			KG	LBS	KG	LBS
G1-MG80	586	479	230	230	189	91	1319	2907	8 X 91	8 X 200



FLAT BENCH

3-point foot contact for stability • Bench anchors for improved stability

	PRODUCT DIMENSIONS (L X W X H)						PRODUCT WEIGHT	
	CM		INCHES				KG	LBS
G1-FW151	155	56	46	61	22	18	35	77



ADJUSTABLE DECLINE BENCH

Back pad easily adjusts to 4 positions from 0 to 30-degree decline • Legs are supported and knees elevated to reduce lower-back strain • Integrated wheels for easy transport within facility

	PRODUCT DIMENSIONS (L X W X H)						PRODUCT WEIGHT	
	CM		INCHES				KG	LBS
G1-FW152	208	63	97	82.0	25	38	50	110



ADJUSTABLE INCLINE BENCH

Easily adjusts to 6 positions from 0 to 75 degrees • Seat pad position is fixed at 15 degrees • Integrated wheels for easy transport within facility

	PRODUCT DIMENSIONS (L X W X H)						PRODUCT WEIGHT	
	CM		INCHES				KG	LBS
G1-FW153	155	61	48	61	24.0	19	41	90



UTILITY BENCH

Back angle is at 85 degrees, improving comfort and stability for overhead movements • Integrated foot supports enhance stability

	PRODUCT DIMENSIONS (L X W X H)						PRODUCT WEIGHT	
	CM		INCHES				KG	LBS
G1-FW156	114	56	102	45.0	22	40	22	48



PREACHER CURL BENCH

Elbow pad is angled at 55 degrees for varying resistance and improved user comfort • Ratcheting seat pad is angled at 10 degrees for enhanced stability and comfort

	PRODUCT DIMENSIONS (L X W X H)						PRODUCT WEIGHT	
	CM		INCHES				KG	LBS
G1-FW155	119	72	95	47	28	37	82	



BACK EXTENSION

Bench is angled at 45 degrees for easy entry and exit • Twist-locking pull pin improves stability of pads

	PRODUCT DIMENSIONS (L X W X H)						PRODUCT WEIGHT	
	CM		INCHES				KG	LBS
G1-FW162	127	74	86	50	29	34	45	



OLYMPIC FLAT BENCH

Easy spotter access • Integrated weight-storage horns keep plates in close proximity • Footrest enhances user stability

	PRODUCT DIMENSIONS (L X W X H)						PRODUCT WEIGHT	
	CM		INCHES				KG	LBS
G1-FW163	176	201	127	70	79.0	50	65	144



OLYMPIC INCLINE BENCH

Bench is angled at 30 degrees to emphasize upper pectoral activation • Adjustable ratcheting seat accommodates a variety of users

	PRODUCT DIMENSIONS (L X W X H)						PRODUCT WEIGHT	
	CM		INCHES				KG	LBS
G1-FW164	178	155	137	70	61	54	68	150



OLYMPIC DECLINE BENCH

Bench is angled at -15 degrees for effective pectoral activation • Adjustable knee support accommodates a variety of users • 3 takeoff positions provide adaptability for users with varying arm lengths

	PRODUCT DIMENSIONS (L X W X H)						PRODUCT WEIGHT	
	CM		INCHES				KG	LBS
G1-FW165	178	218	132	70	86	52	80	176

Weight plates and Olympic bar are not included.



SMITH MACHINE

Bar travel limited to 72 cm / 28.5" from the floor • 6 integrated weight-storage horns • Adjustable stops flip in and out for easy access

	PRODUCT DIMENSIONS (L X W X H)						PRODUCT WEIGHT	
	CM		INCHES				KG	LBS
G1-FW161	205	141	229	80.5	55.5	90	135	297

Weight plates are not included.



WEIGHT TREE

6 weight-storage horns positioned to fit all sizes of Olympic plates • Rubber bumpers protect frame finish

	PRODUCT DIMENSIONS (L X W X H)							PRODUCT WEIGHT	
	CM			INCHES				KG	LBS
G1-FW157	67	54	127	26	21	50	15	33	



10-PAIR DUMBBELL RACK

Offset angle prevents wrist strain when removing and replacing dumbbells • Individual dumbbell cradles provide secure storage • Storage space for 10 pairs of dumbbells

	PRODUCT DIMENSIONS (L X W X H)						PRODUCT WEIGHT	
	CM		INCHES		KG	LBS		
G1-FW159	244	66	72.5	96	26	28.5	100	220



BARBELL RACK

Upright design provides easy access to barbells • Rack holds 10 barbells, 5 per side

	PRODUCT DIMENSIONS (L X W X H)							PRODUCT WEIGHT	
	CM			INCHES				KG	LBS
G1-FW160	99	84	150	39	33	59	55	121	

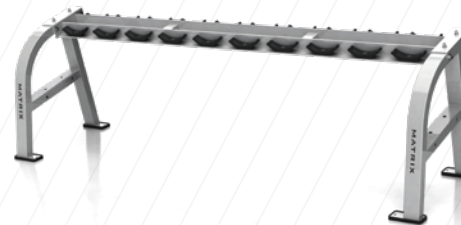

5-PAIR DUMBBELL RACK

Storage space for 5 pairs of dumbbells • Offset angle prevents wrist strain when removing and replacing dumbbells • Individual dumbbell cradles provide secure storage

	PRODUCT DIMENSIONS (L X W X H)						PRODUCT WEIGHT	
	CM		INCHES		KG	LBS		
G1-FW158	244	66	72.5	96	26	28.5	63	139

G1 STANDARD FRAME AND UPHOLSTERY COLORS

Iced Silver frames

Obsidian Black – Upholstery



Clay Red – Upholstery

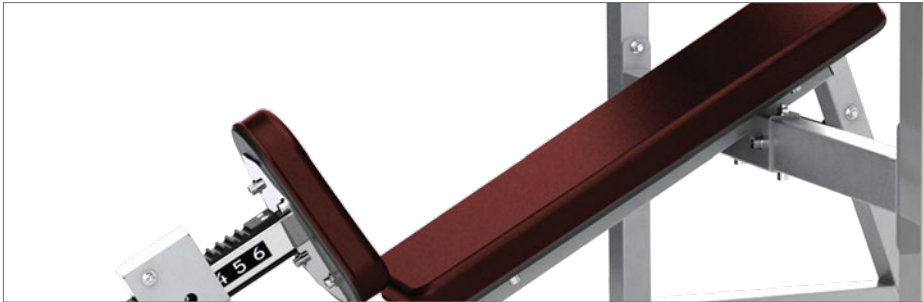

Slate Blue – Upholstery



Matte Black frames

Obsidian Black – Upholstery



Clay Red – Upholstery



Slate Blue – Upholstery



NOTE: All specifications are subject to change without notice. Actual products may differ from those pictured in this catalog. Actual product colors may vary from what is shown here.



A TRULY GLOBAL COMPANY



AUSTRALIA / NEW ZEALAND

Johnson Health Tech Australia Pty. Ltd.

BRAZIL

Johnson Health Tech Brasil

CANADA

Johnson Health Tech Canada

CHINA

Johnson Health Tech (Shanghai) Co., Ltd.

CZECH REPUBLIC / SLOVAKIA

Johnson Health Tech CZ & SK a.s.

DENMARK

Johnson Health Tech Denmark ApS

FRANCE

Johnson Health Tech France

GERMANY / AUSTRIA

Johnson Health Tech GmbH

GREECE / BULGARIA / CYPRUS

Johnson Health Tech Hellas SA

HONG KONG

Johnson Health Tech Hong Kong

ITALY

Johnson Health Tech Italia Spa

JAPAN

Johnson Health Tech Japan

KOREA

Johnson Health Tech Co., Ltd. Korea

MALAYSIA

Johnson Fitness (Malaysia) SDN. BHD.

MEXICO

Johnson Health Tech Mexico

NETHERLANDS / BELGIUM /

LUXEMBOURG

Matrix Fitness Benelux

PHILIPPINES

Johnson Health Tech Philippines Inc.

POLAND

Johnson Health Tech Sp. Z. O. O.

ROMANIA

Johnson Health Tech Romania

RUSSIA

Johnson Health Tech Russia

SOUTH AFRICA

Johnson Health Tech South Africa (PTY) Ltd.

SPAIN / PORTUGAL

Johnson Health Tech Ibérica SL

SWITZERLAND

Johnson Health Tech (Schweiz) GmbH

TAIWAN

Johnson Health Tech Taiwan

THAILAND / CAMBODIA /

LAOS / MYANMAR

Johnson Health Tech
(Thailand) Co., Ltd.

TURKEY

Johnson Health Tech Turkey

UNITED ARAB EMIRATES / SAUDI ARABIA / KUWAIT / QATAR / OMAN / JORDAN

Johnson Health Tech Middle East

UNITED KINGDOM

Johnson Health Tech UK Ltd.

UNITED STATES

Johnson Health Tech North America

VIETNAM

Johnson Health Tech (Vietnam) Co. Ltd.

Visit matrixfitness.com for full contact information.

MATRIX

ABOUT MATRIX FITNESS

In 2001, Johnson Health Tech established Matrix Fitness to bring premium fitness equipment to the marketplace. Since then, we've become the fastest-growing commercial fitness equipment brand in the world. Matrix has leveraged continuous innovation and cross-cultural collaboration to emerge as an industry vanguard, constantly challenging standards and raising expectations for fitness equipment design and exercise technology.

Our product portfolio has expanded to over 600 products including strength equipment, cardio platforms, group exercise modalities, athletic performance training tools, fitness technology, integrated HIIT workouts, turnkey programming and much more. With nearly 40 subsidiaries around the world, Matrix is uniquely equipped to meet fitness and wellness needs in every corner of the globe.

Today, Matrix Fitness is dedicated to serving fitness facilities of all kinds, setting them apart in ways that attract and retain more members. Our mission is to delight and excite our customers through complete solutions and committed partnership provided by a world-class organization.





MATRIX
Strong • Smart • Beautiful

Matrix Fitness

1600 Landmark Drive
Cottage Grove, WI 53527 USA

matrixfitness.com

©2024 Matrix Fitness. All Rights Reserved.

AUTHORIZED MATRIX FITNESS DISTRIBUTOR